



NORSK POLARINSTITUTT

# RAPPORTSERIE

NR. 57 - OSLO 1990

VLADIMIR VOLKOV and TORGNV VINJE

SOVIET - NORWEGIAN OCEANOGRAPHIC PROGRAMME

1988 - 1992

CRUISE REPORTS 1989



*Denne boka tilhører  
Norsk Polarinstittutt  
La den ligge på avisrommet!  
Takk!*



B. RUDELS, C. ERICHSEN, A.Yu. PROSHUTINSKY,

Ye.U. MIRONOV and A.A. LEBEDEV

## CRUISE REPORT

R/V AKADEMIK SHULEYKIN

24 APRIL - 23 MAY 1989



**TABLE OF CONTENT**

	Page
INTRODUCTION .....	1
SCIENTIFIC RESULTS .....	2
PERFORMANCE .....	3
COMMENTS .....	3
APPENDIX A : CRUISE PARTICIPANTS .....	A1
APPENDIX B : FIGURES .....	B1

## INTRODUCTION

Among the objectives of the Soviet-Norwegian Oceanographic Programme (SNOP) are observations of the water exchanges between the Polar Ocean and the North Atlantic through the straits between the Greenland and Franz Josef Land and studies of the circulation and mixing processes in the northern Barents Sea, the Fram Strait and the Polar Ocean.

The first expedition of the programme was made in April-May to the Fram Strait by the Soviet research vessel "Akademik Shuleykin" with the participation of two Norwegian oceanographers.

The primary purpose of this first cruise was to exchange experiences and routines and to prepare for the use of Norwegian equipments on a Soviet research vessel. A necessary task for a successful future cooperation.

The ice conditions only permitted work in the eastern part of the Strait and the observations were concentrated to studies of the flow of Atlantic water in the West Spitsbergen current and of the interactions between this current and the waters from the Greenland Sea. Observations of the water mass distributions in the molloy fracture zone was also undertaken.

R/V "Akademik Shuleykin" worked between 28 April to the 8 May in the area. Two current meter moorings were deployed on the 28th on the Svalbard continental slope at 79°N. The moorings were positioned at 700m and 1200m depth and were retrieved 7 days later. Each mooring had two Aanderaa RCM-7 current meters measuring speed, direction, temperature and conductivity placed at 30m and 230m above the bottom. The systems were also equipped with "Oceano" acoustic releases.

63 CTD stations, all to the bottom, were taken with the Norwegian NBIS Mark III instrument. At 20 of these stations casts were also made with the Soviet Hydrosond and 24 bottles Rosett. The water samples were analysed for oxygen, nutrients and salinity (fig. B1, appendix B).

## SCIENTIFIC RESULTS

The observation intervals on the current meters were 10 minutes and all instruments worked properly.

The obtained time series are too short to allow for any transport estimates for the West Spitsbergen current. However, it should be possible to perform tidal analysis and also to examine if any indications of topographically trapped motions are present.

At the present stage reading and analysis of the current meter data are not possible on board the ship, and the data will be processed in Bergen after the cruise.

The CTD observations yield to some preliminary reflections.

The well known eddy like circulation over the fracture zone is clearly revealed (Fig. B2, appendix B) and several instances of splitting and possible recirculation of the Atlantic water in the West Spitsbergen current are present (Fig. B3, appendix B).

Interactions between different water masses occur at all levels, in the top layer between polar surface water and Atlantic water, at intermediate levels between waters from the Greenland Sea and from the West Spitsbergen current and in the deep between the different deep waters (Fig. B4, appendix B).

Especially prominent is the cold, low salinity cyclonic eddy on the slope east of the fracture zone (Fig. B2 and B3). Its T-S characteristics (Fig. B5, appendix B) indicate that it originates from the Greenland Sea and its presence on the slope shows that intermediate water from the Greenland Sea may, intermittently, be carried by the West Spitsbergen current into the Polar Ocean.

The T-S structure in the deeper layers of the West Spitsbergen current is cold and of low salinity, suggesting a recent mixing, perhaps across the Mohn Ridge, with Greenland Sea deep water.

In the large depths of the molloy fracture zone the presence and mixing of Greenland Sea deep water and Eurasian Basin deep water were seen.

The CTD data will be processed in Oslo after the cruise.

## PERFORMANCE

With respect to the main objective of the cruise: The exchanges of the experiences and methods, the cruise was a success. The capability of the ship, its crew and its hydrographic team in performing the different tasks: Positioning occupation of stations, deployment and recovery of mooring systems, as well as solving those unexpected problems, which always arise, was excellent.

As for instrumentation the current meters and the releases worked without malfunctions. Some unfortunate choices of number of connected floats, of the relative positions of floats and current and the omission of turners between the floats will be corrected for future deployments.

The NBIS CTD could be connected without difficulties to the winches of the ship and it worked well throughout the cruise.

However, one serious problem is the disturbances on the working of the winches caused by radio transmissions from the ship. It could have resulted in the loss of an instrument and has to be remedied.

The salinity observations by the NBIS CTD agreed within 0.002 with the salinities measured on the salinometer onboard and the accuracy of the salinity of the unprocessed data should be better than 0.005.

## COMMENTS

It has been a fruitful and enjoyable time and we are glad to have participated in this first cruise and are convinced that future work in the SNOP will run without unsurmountable difficulties.

APPENDIX A

## CRUISE PARTICIPANTS

Name	Institution	Profession
Proshutinsky, A.YU.	AARI	Oceanography, Expedition Leader
Mironov, YE.U.	AARI	Oceanography
Lebedev, A.A.	AARI	Oceanography
Rudels, B.	NPRI	Oceanography
Erichsen, C.	U.of.B.	Oceanography

Abbreviations :

AARI = Arctic and Antarctic Research Institute, Soviet  
 NPRI = Norwegian Polar Research Institute, Norway  
 U.of.B. = University of Bergen, Norway

**APPENDIX B**

**FIGURES**



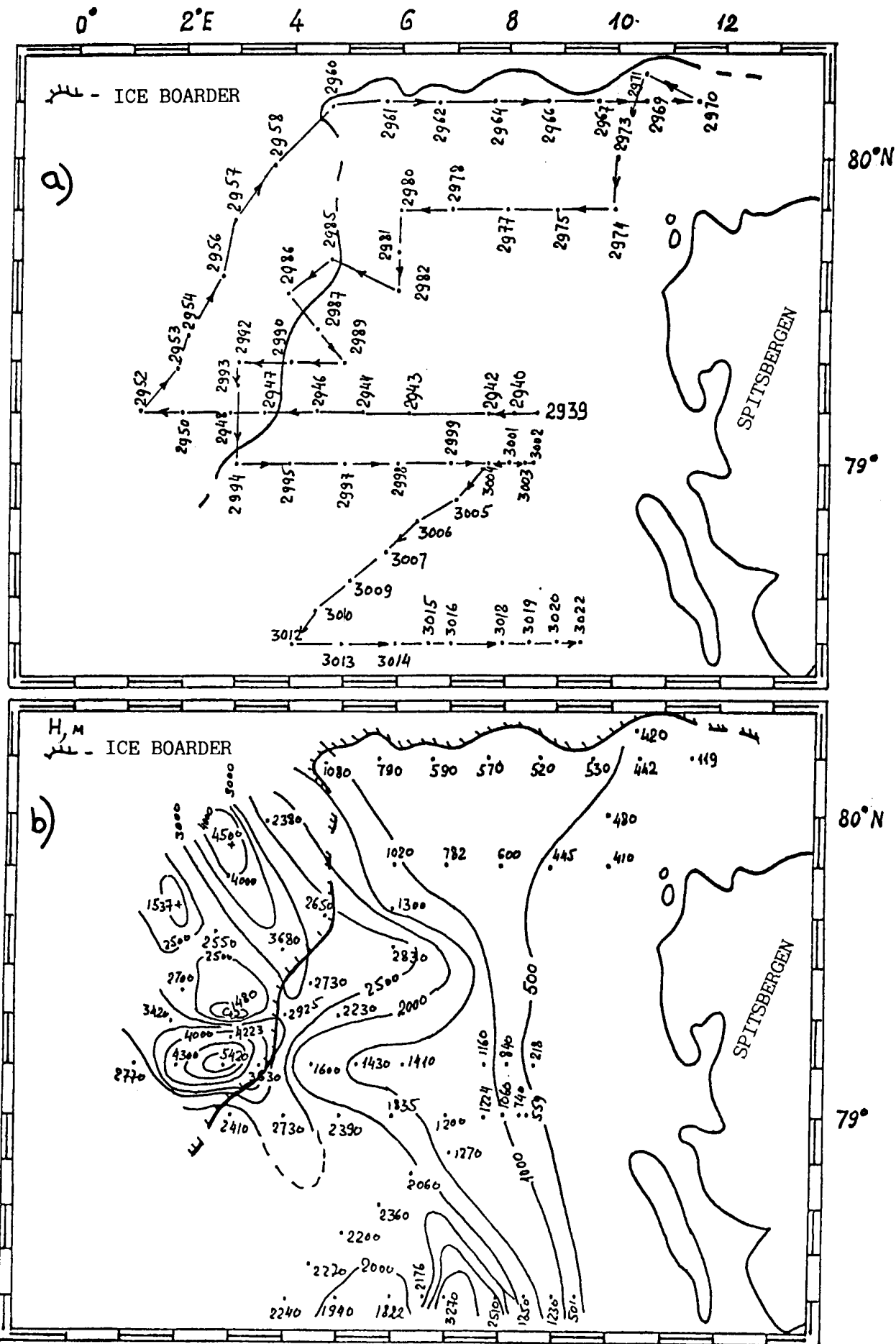

Fig. B1 a) Positions of the CTD-stations taken in the Fram Strait during this SNOP cruise.  
 b) Bottom topography with the depths of the stations.

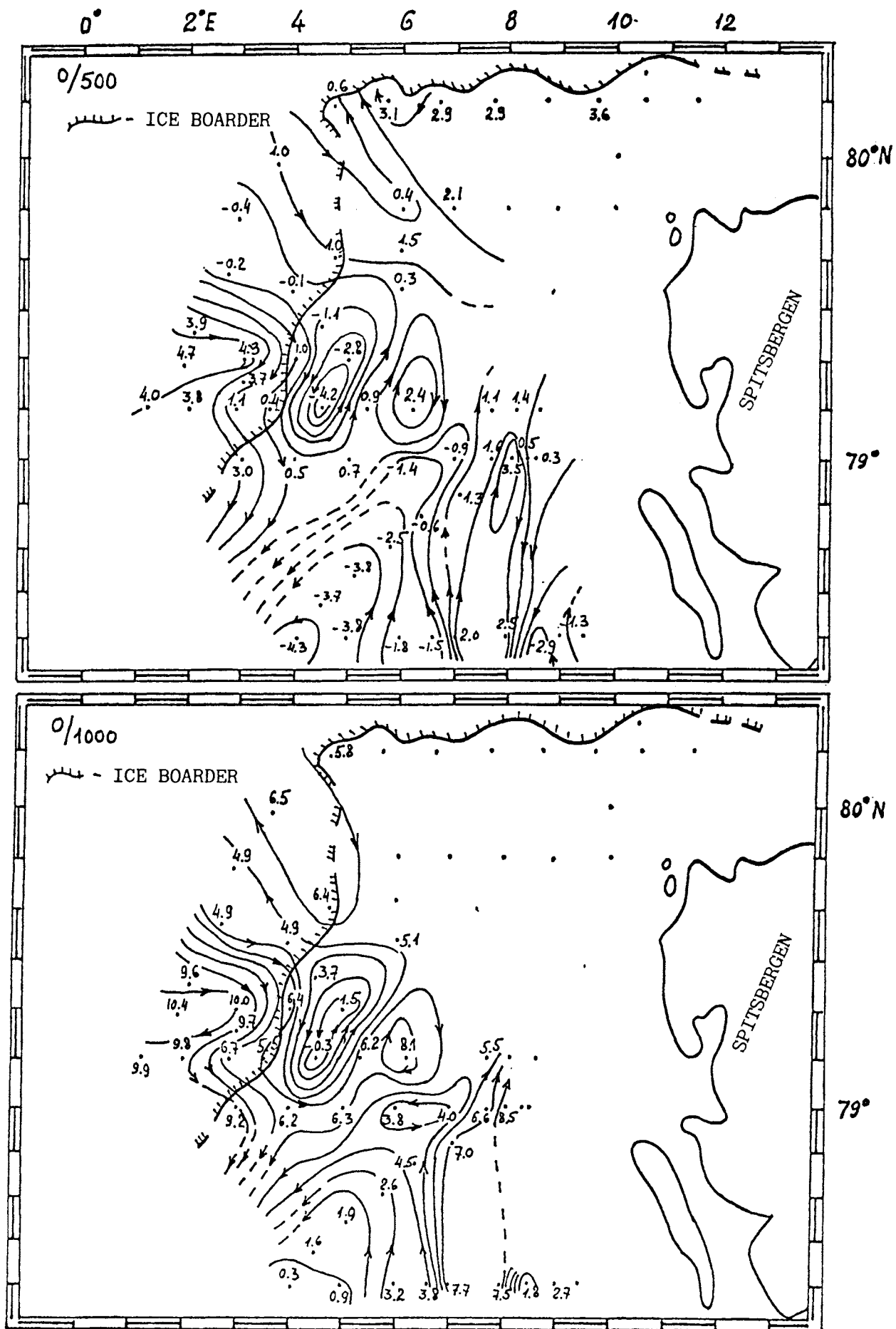

Fig. B2 Dynamic topography and surface circulation calculated with reference levels a) 500 db b) 1000 db. Isolines and values in dynamical cm.

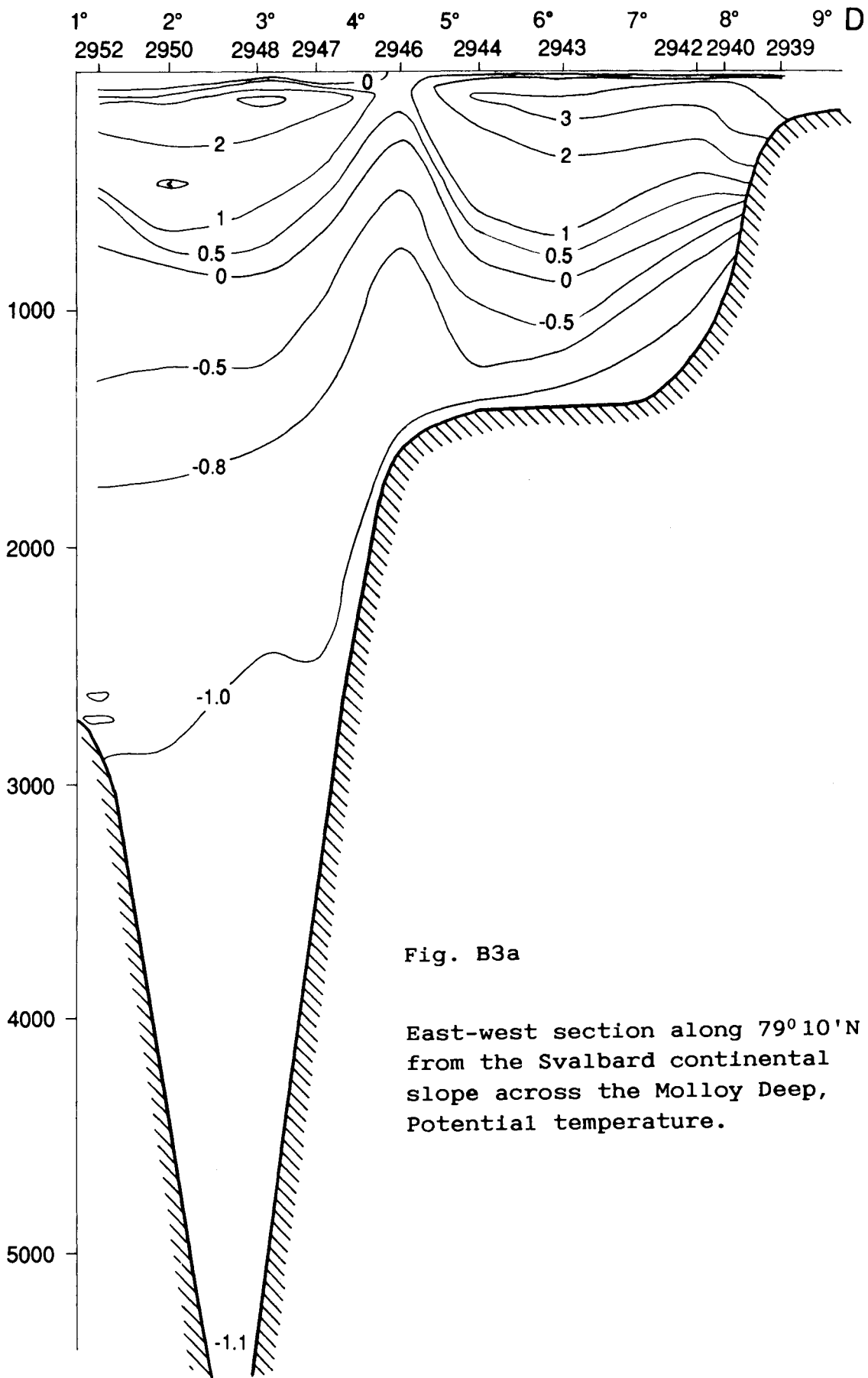

Fig. B3a

East-west section along 79° 10' N  
from the Svalbard continental  
slope across the Molloy Deep,  
Potential temperature.

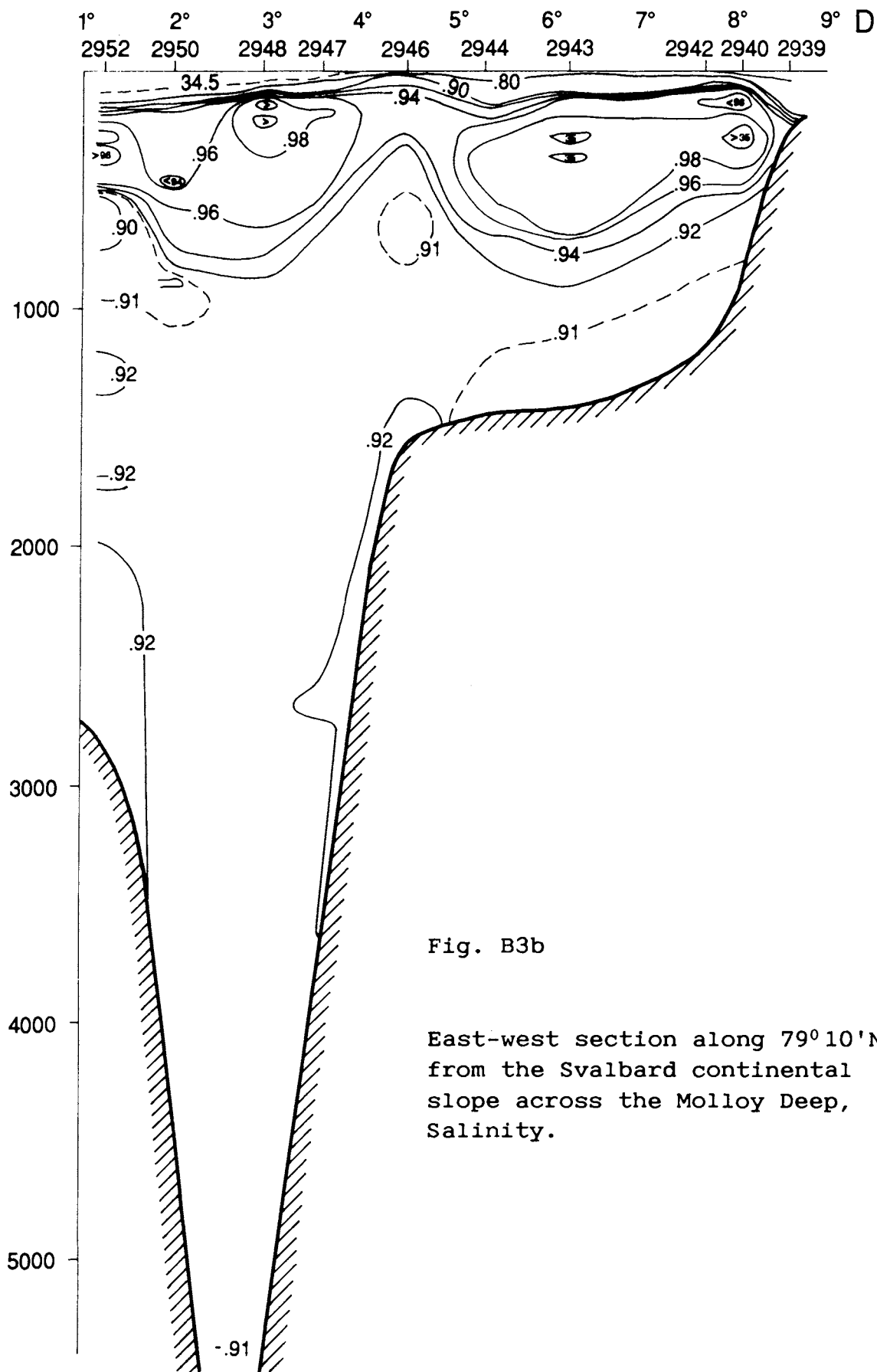

Fig. B3b

East-west section along  $79^{\circ}10'N$   
 from the Svalbard continental  
 slope across the Molloy Deep,  
 Salinity.

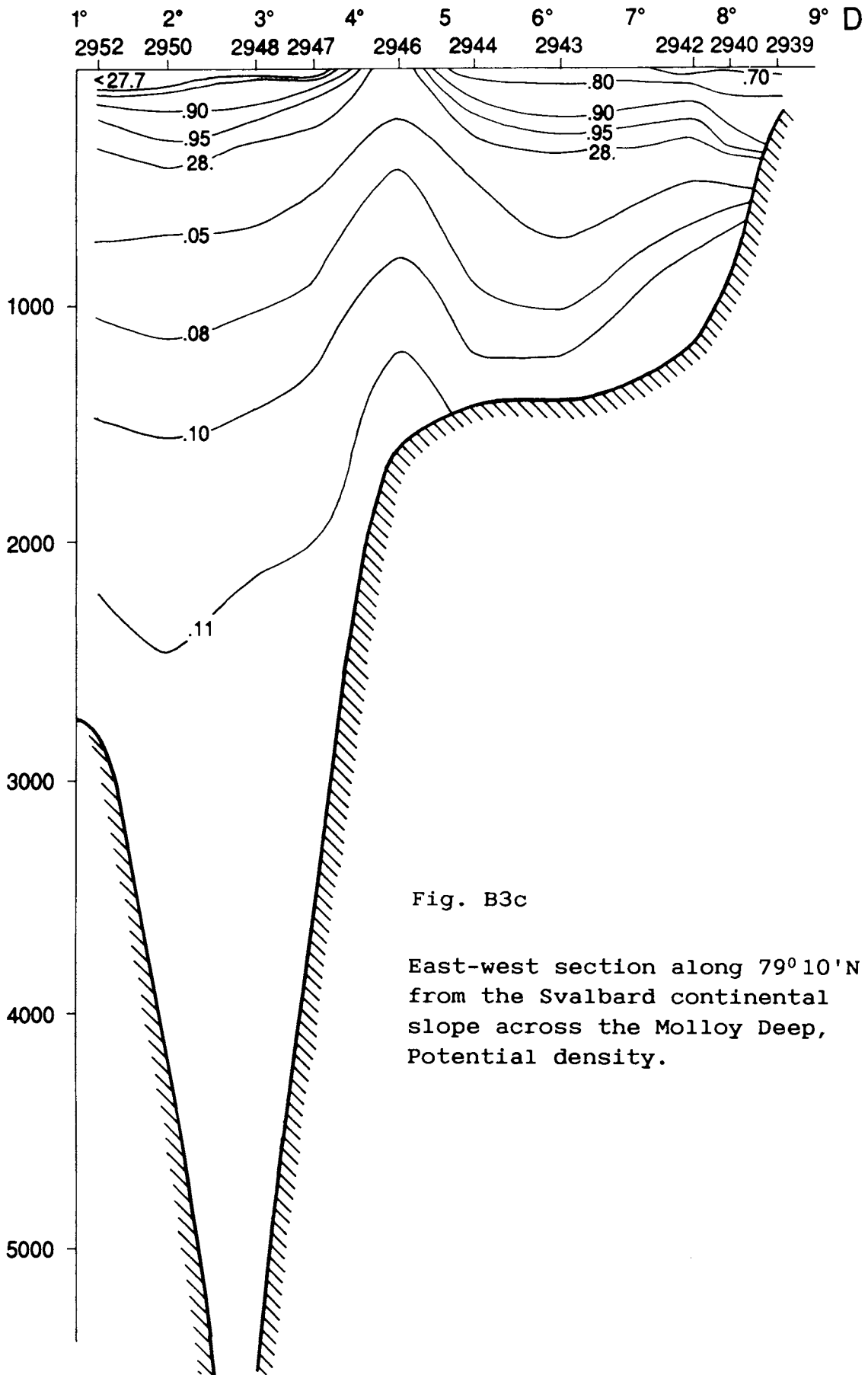

Fig. B3c

East-west section along  $79^{\circ} 10' N$   
 from the Svalbard continental  
 slope across the Molloy Deep,  
 Potential density.

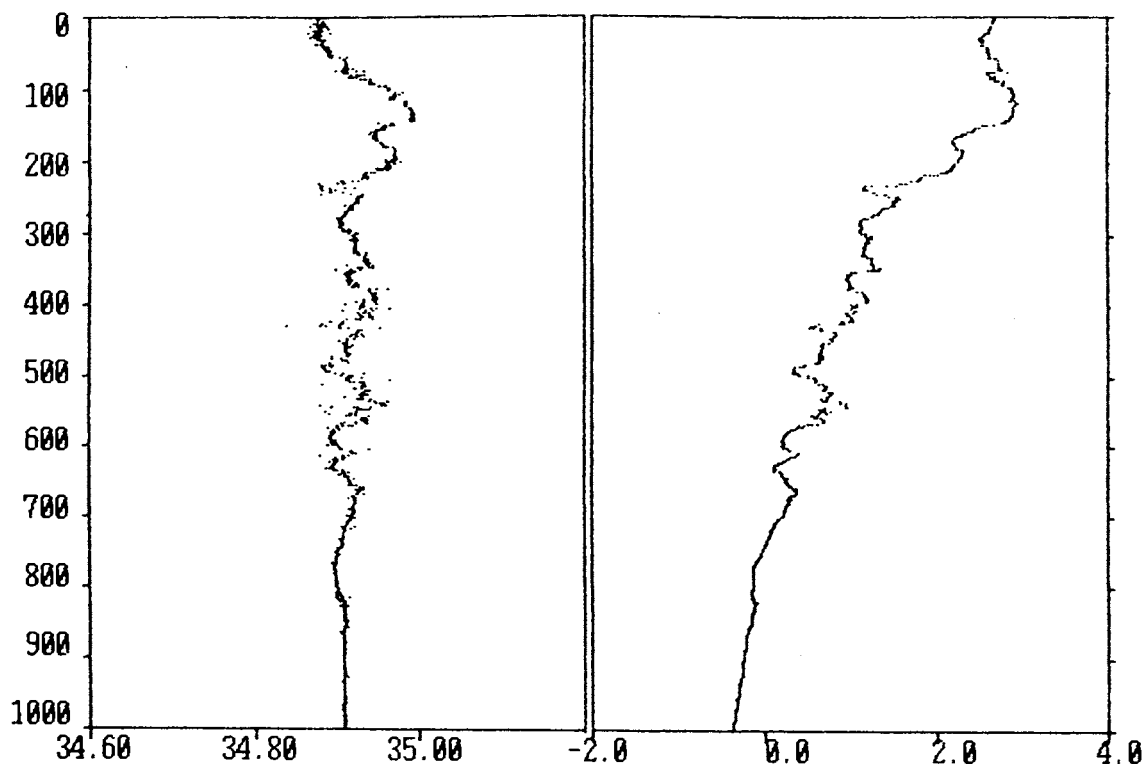

Fig. B4a Profiles of temperature (right) and salinity (left) for the upper 100 db for station 2995.

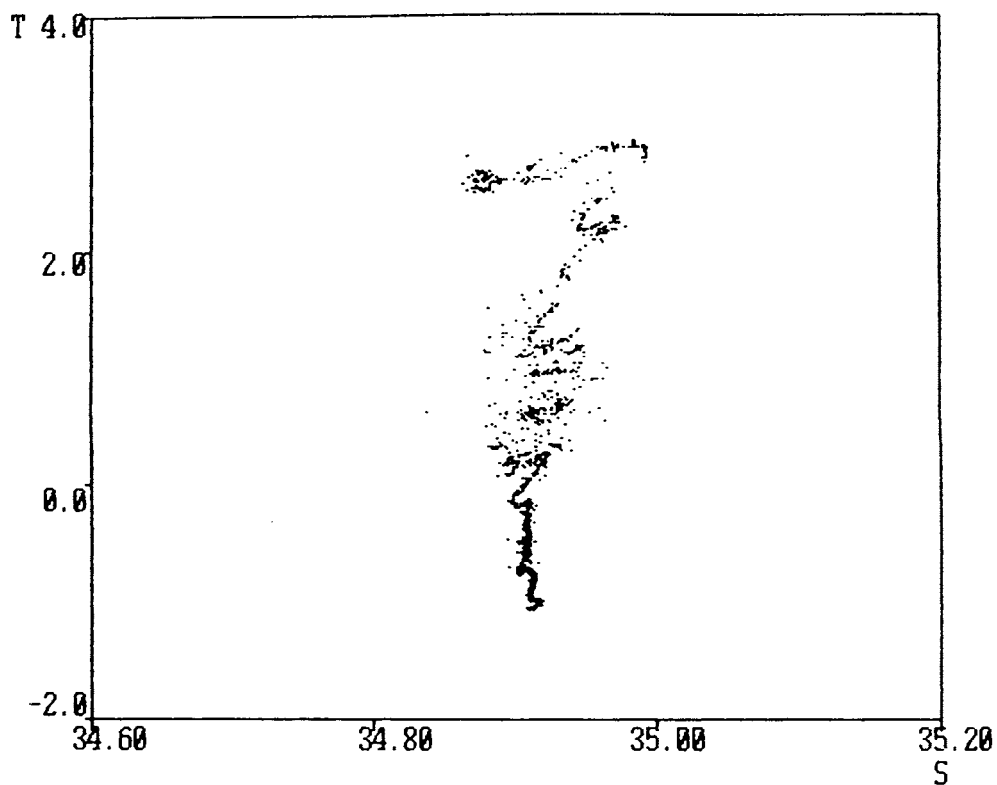

Fig. B4b Potential temperature-salinity plot for station 2995.

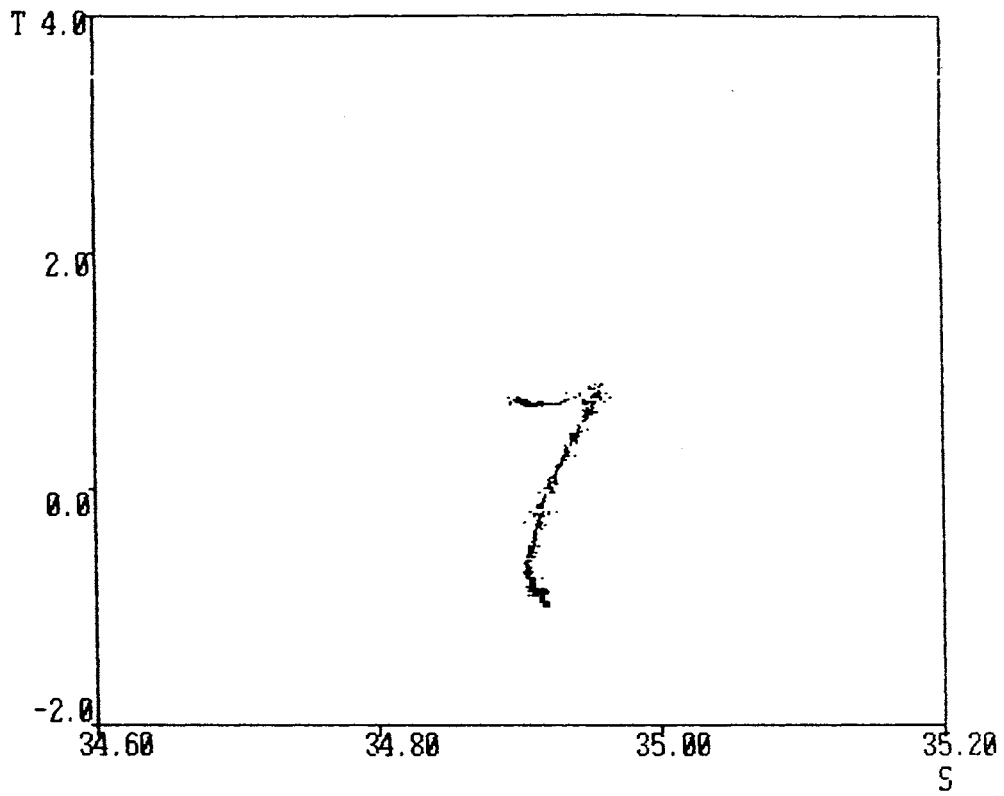

Fig. B5 Potential temperature-salinity plot for station 2946.

VLADIMIR VOLKOV and TORGNV VINJE

## CRUISE REPORT

R/V AKADEMIK SHULEYKIN

24 JULY - 14 AUGUST 1989





## TABLE OF CONTENT

	Page
PROGRAMME SCHEDULE .....	1
INSTRUMENTS, METHODS AND DATA .....	3
SEA ICE CONDITIONS .....	6
OCEANOGRAPHY .....	9
WEATHER CONDITIONS .....	11
THE AUTONOMOUS CIPHER CURRENT-METER ACIT-U-01 (vector) ..	12
INSTRUMENTED MOORINGS .....	13
AUTOMATIC BUOYS AND USE OF SCANNING SONAR .....	14
APPENDIX A : CRUISE PARTICIPANTS .....	A1
APPENDIX B : FIGURES .....	B1

## PROGRAMME SCHEDULE

A regular net with 30 nm intervals, used at the AARI for numerical hydrothermodynamic model calculations has been adopted as the basis for the scheme of the oceanographic CTD survey.

In accordance with the agreement the Soviet-Norwegian oceanographic programme (SNOP) should be executed mainly in the region between 78°N and 82°N. The execution of the programme in the maximum planned volume was feasible only in connection with favourable ice conditions. According to data of the Department of Ice Regime and Prognosis at AARI the ice cover of the Barents Sea was at the end of February close to the long term mean. However, in stead of an ice export from the Barents Sea which is the normal case, a considerable advection of ice from the Arctic Basin took place. The quantity of old ice in the northern part of the sea reached 5/10, the general concentration being up to 9-10/10. Thus, the tendency towards an amelioration of the ice conditions, noticed at the beginning of the year, did not develop further, and the ice conditions in the area of investigation was expected and subsequently observed to be difficult for navigation in July and August. The southern ice edge at this time had taken an anomalous position, which at this period is quite rarely observed.

The working programme had therefore to be corrected and adapted to the actual ice condition in the region visited. The operative planning of the work was achieved on the basis of synoptical and satellite maps of ice conditions, of weather forecasts, regularly received from the Murmansk Administration of the Hydrometeorological Service of the USSR.

In accordance with the plan "Akademik Shuleykin" left Murmansk on July 22nd 1989 and arrived at the port of Hammerfest on July 24th, where four Norwegian scientists, instruments and equipment were taken on board.

As there was comparatively good ice conditions in the western part of the straits between Svalbard and Zemlya Frantsa Iosifa (ZFI), we started the work in this area. The Soviet complex "GIDROZOND" and the U.S hydrosonde "Neil Brown" were compared en route. We arrived in the region of Kvitøya on July 28th, where two moorings were deployed.

Having deployed the moorings we set course southwards, carrying out an oceanographic survey between the coasts of Svalbard and the western boundary at the ice fields which occupied the central part of the northern half of the Barents Sea. At 77°43'7 N - 31°50'0 E we released a mooring, deployed in 1988 from the Norwegian vessel "Lance". Then, rounding the ice fields going south-eastwards and taking oceanographic observations every 30 miles we turned northwards in the region of 50°E after having navigated through an ice belt with a concentration of 1 to 3/10. We there entered the vast recurring polynya to the south of ZFI. Having moved northwards as far as the ice conditions permitted we deployed a third mooring. We established an automatic Argos station on an iceberg, and carried out an oceanographic microsurvey around the iceberg in a radius up to one mile (in all 10 stations). The work at this stage was carried out in an area with an ice concentration varying between one and six units, and limited visibility.

Passing southwards along the eastern ice edge, we brought the survey to an end. Two ICEXAIR stations were deployed in the drift ice. The bottom topography of one ice floe was surveyed by means of a scanning sonar. On August 8th one more Argos station was deployed on a capsized fragment of an iceberg about 50 x 60 metres in dimensions. The iceberg tracking project was funded by Operatør komitè Nord, an association of 11 Norwegian and foreign oil companies with operational responsibilities in the Western Barents Sea.

Heading towards Hammerfest we made observation in a micro-polygon near the southern part of the ice edge.

As an analysis of satellite ice maps showed, the work tactics of the expedition had been correct. The deployment sites of the moorings were covered with heavy ice only a couple of days after the exit of the vessel from these areas.

On August 14th R/V "Akademik Shuleykin" arrived at Hammerfest.

A number of oceanographic and meteorological investigations (including ice investigations) were carried out during the expedition; aerological observations and hydrochemical determinations were made as well.

The work in this region is to be continued by the ordinary SNOP expedition on the R/V "Lance" with participation of a group of Soviet scientists.

## INSTRUMENTS, METHODS AND DATA

### Oceanography

The oceanographic part of the programme was carried out using instruments and equipment of the ship-borne complex as well as instruments and equipment supplied by Norwegian scientific organizations:

- a CTD hydroprobe (of Soviet production) with a cassette for a 24 litre bathometer and with loggers of temperature (from  $-2^{\circ}$  to  $+32^{\circ}\text{C} \pm 0.03^{\circ}\text{C}$ ) of electric conductivity of 0.5 to  $6.5 \text{ cm/m} \pm 0.004 \text{ cm/m}$ ) of pressure (from 0 to 60 mPa  $\pm$  (0.04 - 0.06 mPa))
- a CDT "Neil Brown" (Mark III)
- a gauge "Aanderaa" RCM - 7
- a mareograph "Aanderaa" TG-3A
- a ship-borne computer SM-4, and two personal computers Toshiba 3100RC. Rope and cable winches (up to 8000 m), hydraulic  $\Pi$ -shaped frames, and a hydraulic crane with a range of the jib of 12 m are available for deployment of buoy stations and securing work on the ice. The vessel has passive Interling stabilizers of rolling, and a Jastra steering device to provide convenience and security in the execution of oceanographic work.

Main activities performed:

- 42 oceanographic CTD stations "hydroprobe"
- 97 oceanographic CTD stations "Neil Brown"
- deployment of three moorings for long term observation of currents and ice (scheme and parameters of the moorings are presented in appendix)
- retrieved one mooring with a RCM gauge and a CMI upward looking sonar, deployed 09.09.88 from R/V "Lance" in  $77^{\circ}43'7\text{N} - 31^{\circ}50,0\text{E}$
- carried out two comparative series of soundings of CTD "Neil Brown" and of the experimental CTD probe ACIT-U-02.

### Sea ice

Visual observations were taken of the distribution and characteristics of the sea ice and icebergs according to the "Mezdunarodnaja simvolika dlja morskich ledovykh kart i nomenklatura morskich l'dov" ("International symbolics for sea ice charts and nomenclature of sea ice") - Gidrometeoizdat, Leningrad, 1984, 65 pp. A ship-borne locator was used to determine the dimensions of icebergs and

the position of the ice edge, particularly in conditions of limited visibility. An ice chart was compiled from the results of the observations.

Two ICEX buoys were deployed on icebergs:

06.08 Argos 1791 in 79°54 N - 49°21 E

08.08 Argos 1792 in 78°16 N - 56°31 E

Two ICEXAIR buoys were deployed on drift ice:

07.08 Argos 1872 in 79°31 N - 50°05 E

08.08 Argos 1873 in 78°33 N - 56°07 E.

A survey of the bottom topography of the ice floe with Argos 1872 was carried out with a Mesotech 971 scanning sonar.

### Hydrochemistry

All the hydrochemical observations were made on board the ship. Sea water samples were analysed using instruments of the ship-borne complex:

- salt gauge GM-650 (Soviet production), range of measurements from 0.021 to 1.276 with an error in the main range of 0.793 - 1.176 of less than  $\pm 0.0005$ . Normal water was used for calibration of the instrument, produced by the analytic laboratory of the Institute of Oceanology of the Academy of Sciences of the USSR. The salinity was calculated using formulae from "International Oceanographic Tables" (UNESCO). The samples were thermostated before determination.
- the determination of the contents of dissolved oxygen was achieved by the method of Winkler in a modification adopted in the USSR.
- the determination of phosphates was achieved by the method of Murphy-Riley on a photoelectrocolorimeter FEK-60 (USSR).
- the determination of silicates, nitrates, and nitrites was achieved on an automatic analyzer AKEA (production of DATEX, Finland) by methods recommended by the firm: for silicates - according to Grasshoff, for nitrates and nitrites - according to Wood, Armstrong, Richards.

The following analysis were carried out:

salinity	-	407 at 42 stations
oxygen	-	407 at 42 stations
phosphatic phosphorus	-	407 at 42 stations
silicate silicon	-	294 at 30 stations
nitric nitrogen	-	241 at 25 stations
nitritic nitrogen	-	252 at 25 stations

For comparative determination of salinity at Norsk Polar-instituttt in Oslo, 21 samples of water were taken parallely from the same bathometers at four stations.

### Meteorology

Meteorological and radiation parameters were recorded by the ship-borne automatic weather station "Midas-321" (Vaisala, Finland) at the terms 00, 03, 06, 09, 12, 15, 18, and 21 GMT direction and velocity of wind, atmospheric pressure, temperature and humidity of the air, temperature of the water, magnitude of total and reflected radiation.

The sea state, quantity, forms and height of clouds, atmospheric phenomena, distance of horizontal visibility, and ice condition were determined visually.

Additional meteorological observations were made at each station of the micropolygon in the region of the ice edge.

### Aerology

Temperature-wind sounding was carried out by the system "CORA-RS-21" (Vaisala, Finland) at the terms 00 and 12 GMT. Altogether 34 radioprobes were emitted during the period of work from 27.07 (00 GMT) to 11.08 (12 GMT). The mean height of sounding was 27.5 km. Operative information was transferred in code FM36.E to the Moscow Hydrometeorological Centre.

## SEA ICE CONDITIONS

V.A. Abramov

### Planning and navigation

When elaborating the programme of the 26th voyage of "Akademik Shuleykin" in March 1989 the position of the ice edge of the drift ice for July-August between Svalbard and Zemlya Frantsa Iosifa (ZFI) was depicted at the AARI. The position of the ice edge ruled out the possibility of carrying out detailed oceanographic investigations in this region at the end of July and the first half of August. Nevertheless, if favourable circumstances (diverging wind current) in coastal regions to the east of Nordaustlandet and to the west of the archipelago of ZFI should occur, conditions for execution of investigations might arise. These recommendations oriented the specialists on the whole correctly at the stage of the preparation of the expedition.

Before the departure from Murmansk (July 22nd) and then in Hammerfest (July 24th) at the conference of Soviet and Norwegian specialists it was proposed to start the investigations east of Nordaustlandet which at that time was accessible. Afterwards we planned to approach the region of ZFI from SE, by passing to the south of the heavy ice fields between Nordaustlandet and Kvitøya. These recommendations were made according to satellite data from July 11 - 12 and 21 as well as in accordance with prognosis. The cruise route of "Akademik Shuleykin" is presented on fig. B1 (appendix B). It was presumed that the bulkhead of sea ice in the region of 77° 50 N lat. on the itinerary of the vessel would disappear by the moment of its entrance into this region, and to the south-east of Nordaustlandet a passage, free from close pack ice, was forming. Ice conditions along the ships route are presented on a map (fig. B2, appendix B).

When we approached the region of work (July 28) the ice conditions began to worsen as a consequence of northerly winds. Having finished the investigations and deployed moorings, the vessel headed towards Kong Karls Land.

The passage to ZFI was achieved according to the recommendation presented on fig. B3 (appendix B), where the most complicated leg of the voyage was the narrow passage between 76° 30 and 77° 30 in the eastern part of the Barents Sea. It should be remarked that in this year an extremely late formation of the "southern passage" to ZFI was observed.

When approaching ZFI the ice drift became north-easterly due to southerly winds. It was therefore impossible to get into the region west of ZFI as planned, and oceanographic investigations and deployment of a mooring were made to the south of ostrov Northbruk (Northbrook Island). The regions where the ICEX and ICEXAIR buoys were deployed are shown on the synoptic map.

The exit of the vessel southwards took place in thick fog, though without essential difficulties due to improved ice conditions. Altogether 36 icebergs of a height of more than 10 metres were observed, the larger part in the region of ZFI and to the south of this archipelago.

#### Ice conditions in the Barents Sea during the summer 1989

The changes of ice conditions in the Barents Sea during 1989 distinguished themselves by an essential instability and an opposite tendencies and a change in magnitude. In January the westward and eastward extension of sea ice exceeded considerably the mean many-year value, and in the western region we observed an extreme spread of sea ice not exceeded during the last 60 years. The magnitude of the anomaly in this region reached + 22%, which is the double of the mean square deviation. Starting from February the course of ice processes changed to the opposite, and the area of sea ice was considerably reduced. The change of the anomaly of ice coverage between January and April in the western region reached 34%, whereas in the north-eastern region 33%.

The ice coverage during the summer months (beginning from July) exceeded the norm. Particularly rapidly increased the area of ice in the north-eastern region of the sea, the anomaly of ice coverage being + 17% in July and + 15% in August. Thus, the period of work of the vessel during its 26th voyage coincided with the time of increase of ice in the Barents Sea.

Observations of ice drift east of Nordaustlandet at the end of July showed a southward displacement of the main ice edge of 4 to 5 n.m. per day. This fact indicates entrance of ice from the Arctic Basin into the Barents Sea.

Between 40°E and 50°E the ice edge extended 130 - 150 n.m. farther south than usual in mid-August. To the south of ZFI the ice drifted at this time in north-eastern direction at a velocity of about one knot. The observed displacement of the ice edge indicates that there has been a cyclonic ice drift



in the northern part of the Barents Sea during the interval of time dealt with.

#### Some conclusions

The ice processes in the Barents Sea showed the following peculiarities:

- The opening of the "Southern Passage" to ZFI in the ice belt between the latitudes of  $76^{\circ}30'$  and  $77^{\circ}30'$  N took place at extremely late terms - August 2nd.
- The ice blockade of the northern coast of Novaja Zemlja is probably the most durable one for the last eight years.
- A considerable quantity of drifting icebergs with height more than 10 metres, and with length more than 100 metres were observed north of  $75^{\circ}$ N south of ZFI.
- An anomalously southern position of the ice edge was observed east of  $35^{\circ}$ E in August. Since 1934 a more southern position in August has been observed only in 1968 at  $40^{\circ}$ E and in 1955 and 1969 at  $50^{\circ}$ E.

# OCEANOGRAPHY

V. A. Volkov

## Preliminary results, tasks of SNOP

Investigations in the straits between Greenland and Zemlya Frantsa Iosifa (ZFI) are of fundamental importance for the understanding of hydrophysical processes in the Arctic Oceans as a whole and in the central part - the Arctic Basin, which contain water masses of intrusive origin. The Fram Strait (Greenland - Svalbard) covers the largest section among the Arctic straits (about 770 square km). Through this strait the majority of the ice (fresh-water runoff) that leaves the Arctic Ocean is conveyed by the Transpolar Ice Drift Stream. The strait between Svalbard and ZFI, although representing a smaller section (about 45 square km), also plays an important role in the exchange. This is illustrated by the strong fluctuations observed in 1989 when the direction of the long-term average transfer changed and increased in module by more than 200 per cent.

The SNOP investigations include tasks of observing the spatial structure of oceanographic fields, their medium-scale peculiarities and processes on the border ice - ocean - atmosphere. Taking into account the peculiarities of the ice regime of the region, it is important to obtain data on processes of interaction near the ice edge to evaluate the influence of the ice cover upon the structure of oceanographic fields, including the disturbing impact of icebergs (both in the region of their formation in Svalbard and ZFI and along their drift tracks). Such data are necessary for substantiating numerical models of water circulation, thermodynamic processes, and prognostic sea ice.

Long-term series on temperature and salinity of the water, of currents, of sea level, of thickness and drift of ice, will be obtained from moored instruments in the straits. Together with observations from satellite tracked buoys and satellite imagery these series will serve as a basis for determination of magnitudes of heat and salt exchange and tuning of numerical models.

The data obtained under SNOP provides in our view an opportunity to approach somewhat the solution of the above enumerated tasks.

Because of difficult ice conditions we succeeded in deploying

instrument moorings in the extreme western and eastern parts of the strait only. The total water exchange in the strait must therefore partly be based on calculated data for the 1989-90 season.

The most complete programme was carried out in the strait between Svalbard and Kvitøya, with a detailed CTD survey and deployment of two moorings with current meters and an upward looking sonar. There are also some available archival data from this region. We found that the structure of the water column in this area was similar to previous observations obtained both by Norwegian (Polar Research 1983, 1 N.S., PP. 107-113) and Soviet oceanologists.

Fig. B4 (appendix B) shows Arctic surface water mass in the western part and two nucleus in the eastern part, the upper consisting of modified Barents-Sea water, and the lower of spread, warm Atlantic water.

An areal oceanographic survey in the western part of the region of work gives the best possibilities to interpolate data in knots of the regular net (grid) and to calculate on the numerical model.

The distributions of temperature and of salinity at horizons 0 and 100 m are presented in fig. B5 (a-d) in appendix B.

The lack of oceanographic data in the central region of the northern part of the Barents Sea, may to some extent be complemented by data on the trajectories of the four automatic drift buoys which presumably will move towards south-west. This is best expressed by the 1st type of circulation (according to the classification of Z.M. Gudkovic, see "Sovetskaja Arktika", Nauka, Moskva, 1970), observed in 1989.

The influence of the ice edge on temperature and salinity of the surface water is distinctly seen from the presented propagations. More detailed, this influence will be investigated from the micropolygon survey in the region of the southern ice edge (fig. B6, appendix B), as well as in the region of the iceberg, where the effect on the warmer water flowing around the iceberg is well traced. The disturbing influence of an iceberg, even in comparatively cold waters in the region of ZFI, is observed at a distance of more than one nautical mile (fig. B7 (a-c), appendix B). A more detailed analysis of the observation materials and calculations will be carried out at NP and at AARI by joint efforts.

## WEATHER CONDITIONS

T. Vinje, V. E. Kaljazin, S. N. Kudrjavcev

The crossing from the harbour of Hammerfest to the region of work on 25-27 July took place under the influence of the conditions in the northern part of an anticyclone, with centre over the central part of Europe. Westerly winds of a velocity of 7 to 12 m/s prevailed. As the ship moved on northwards, the temperature of the air and of the water fell, and in the region of work it was from zero to + 5°C and from zero to + 2°C, respectively.

The following days of the month, weather conditions were determined by a small-gradient field of lowered pressure. The velocity of winds of western directions did not exceed 6 to 11 m/c. On 31 July at the end of the day fog was observed with a visibility of 500 to 1000 m.

The first ten days of August the northern part of the Barents Sea was subject to the influence of the north-western to northern part of an anticyclone with a pressure in the centre of 1025 to 1030 mb, situated over the region of West Siberia. On the 2nd - 3rd of August the eastward passage of a cyclone from the west of Spitsbergen provoked a reinforcement of the south-easterly, southerly wind up to 12 - 15 m/s, which kept on for about 12 hours. The rest of the ten day period wind of western directions with a velocity of 5 to 10 m/s were prevailing. Fogs were observed daily, and the visibility deteriorated to 50 m.

The height of waves did not exceed 1.5 m during the whole period. The temperature of the air was within the confines from 0 to + 5°C, that of the water from - 1 to + 4°C.

On the whole synoptic conditions were favourable for the execution of the programme of investigations.

## THE AUTONOMOUS CIPHER CURRENT-METER ACIT-U-01 (vector)

A. A. Krivtsov

Two AARI current meters ACIT-U-01 (vector) were mounted on the SNOP89-3 and SNOP89-5 moorings. The instrument measures mean values of the meridional and latitudinal vector components of current velocity during a fixed interval of time in a semiconductor memory. The memory is tapped by means of a ship-borne block for processing of data B0d-ACIT-U, through an RS-232C interference connector. The meter ACIT-U-01 was equipped with a connector for reading of contemporary measurements through a hydroacoustic canal.

### Technical characteristics :

Current logger	two-component impeller
Range of measurement of current velocity	from 0.02 to 2.0 m/s
Error of measurement of current velocity	(0.02+0.05*V) m/s, where V is velocity of current
Orientation logger	magnetic compass
Error of measurement of direction	± 8 degrees
Sampling intervals	10/30/60 minutes
Maximum memory capacity	8192 measurements
Maximum operation period of feeding block	10,000 hours
Voltage	6 V
Maximum current	500 mcA
Weight with bracket: in air in water	30 kg 22 kg
Hull dimensions: maximum diameter height	0.3 m 1.2 m
Maximum operational depth	6,500 m

## INSTRUMENTED MOORINGS

### S. Østerhus

Two subsurface instrumented moorings (SNOP-89-03 and SNOP-89-04) were deployed in the strait between Nordaustlandet and Kvitøya (fig. B1). The SNOP-89-03 mooring carries two Aanderaa RCM-7 current meters, one AARI current meter, one Aanderaa T6-3A pressure recorder at the bottom, and one Oceano AR361 acoustic release for recovery (fig. B8a, appendix B). The SNOP-89-04 mooring was equipped with one CMI ES-300 III upward looking sonar, two Aanderaa RCM-7 current meters, one Aanderaa T6-3A pressure recorder, and one Oceano AR361 acoustic release (fig. B8b). One subsurface mooring (SNOP-89-05) was deployed south of Zemlya Frantsa Iosifa (fig. B1). It consisted of three Aanderaa current meters, one AARI current meter, one Aanderaa WLR-7 pressure recorder, and one Oceano AR361 acoustic release (fig. B8c).

The sampling interval was eight minutes for CMI ES 300 III and one hour for Aanderaa RCM-7, T6-3A and WLR-7.

Deployment of the moorings went fine, and R/V Akademik Shuleykin was well equipped for this purpose. Some improvement can be done in regard to the safety.

One mooring (ULS-C-51988) was retrieved northeast of Hopen (fig. B1). It consisted of one Mesotech upward looking sonar, one Aanderaa RCM-4 current meter, and one Oceano RT-161 acoustic release.

Retrieval of the mooring went fine, but a rubber boat would have eased the operation considerably.

## AUTOMATIC BUOYS AND USE OF SCANNING SONAR

T. Vinje and Å. S. Johnsen

The Transpolar Ice Drift Stream in the Arctic Ocean generally aims towards the Fram Strait west of Svalbard. There occurred, however, a marked deviation from this scheme during the last half part of 1988 when buoy drifts indicated a perpendicular ice drift, towards the Barents Sea. The expected result of this long lasting deviation was supported by field observations: Vast areas of thick multi-year ice was encountered by R/V Lance in the north-western areas just before the start of the freezing season in September 1988 (Norsk Polar-institutt Rapportserie Nr 49). Together with a negative deviation in the air temperature during the winter season this may be the main causes for the observed extremes in the ice conditions this summer.

ARGOS-buoys were deployed to monitor the long term drift of ice floes and icebergs.

The iceberg tracking buoys (ICEX) were deployed with the aid of a boarding boat at  $79^{\circ}54'N - 48^{\circ}21'E$  on 6 August (ARGOS 1791) and at  $78^{\circ}16'N - 56^{\circ}31'E$  on 8 August (ARGOS 1792). (Fig. 1 (a and b)).

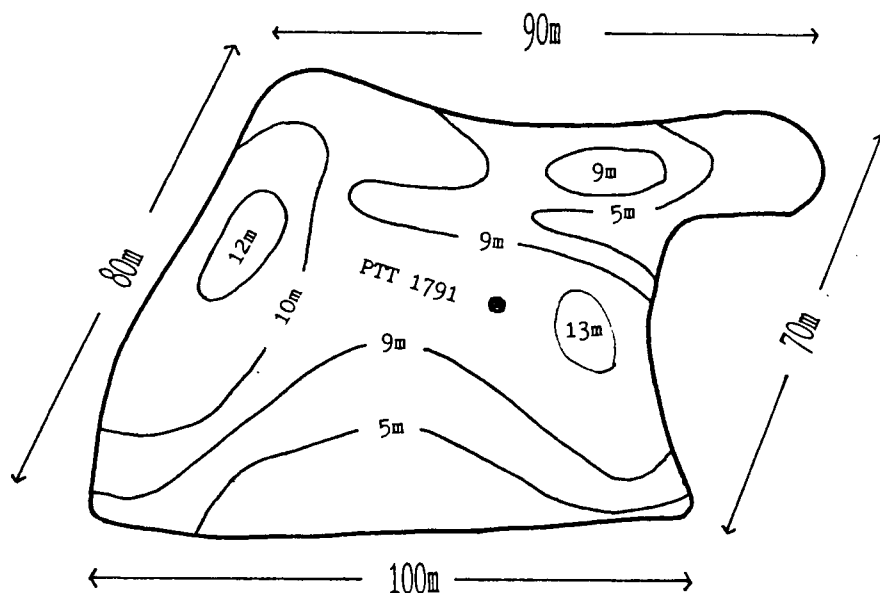

Fig. 1a Iceberg with ARGOS 1791 viewed from above.

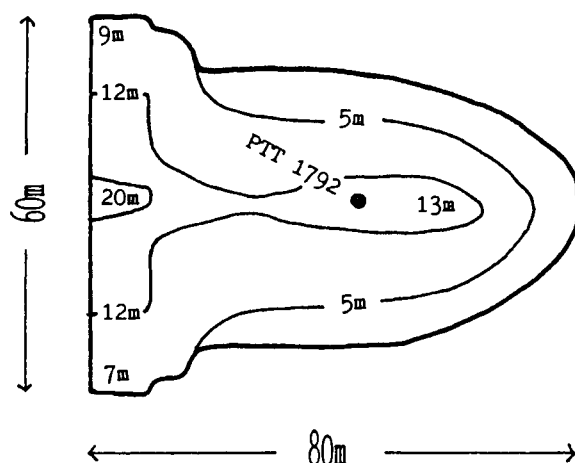

Fig. 1b Iceberg with ARGOS 1792 viewed from above.

Both icebergs were free floating and the latter constituted a  $90^\circ$  tilted part of previous tabular iceberg. The eroding effects of currents and waves during its previous orientation was clearly demonstrated by its present form.

The ICEX buoys are placed in a 2-3 m drilled hole to prevent falling off during the melting season. They have a battery capacity of two years life time. According to the orbiting scheme of the NOAA satellites, positions, ice temperature at 1.8 m depth and air temperature at 0.5 m above the surface will be collected every 90 minutes. The position accuracy is between 350 and 1500 m.

Two ice drift buoys (ICEXAIR) (which can be parachuted on to the ice from aircraft if wanted) were deployed manually on ridges at  $79^\circ 31'N - 50^\circ 05'E$  on 7 August (ARGOS 1872) and at  $78^\circ 33'N - 56^\circ 07'E$  on 8 August (AGOS 1873). These buoys, which also will be operating when free floating, have battery capacity for two years. Information on position etc will be collected via the NOAA satellites every 90 minutes.

The correlation between the observed ice drift and the contemporary geostrophic wind will give information on wind drift factors and the frictional turning angel of value for modelling. The data will also be used in the daily ice services in Norway and USSR.

Apart from positions, the ICEXAIR buoys will also transmit air pressure, tendency and air temperature and add to the synoptic meteorological information from a sparcely covered



area. When the buoy is floating it will also transmit the sea surface temperature. The data will be collected at Service ARGOS in Toulouse and dispatched to NP on monthly intervals. Copies will be sent to AARI. The buoy data will also be collected via the receiving station of the Norwegian Meteorological Institute and transmitted over the GTS for daily international use.

To study the bottom topography of the ice a survey was made by a Mesotech 971 scanning sonar of the ice floe positioned by ARGOS 1872 (fig. B9, appendix B).

The sonar head was lowered through a hole in the ice floe with the aid of a 19 m long, stiff rod. The bottom surface was scanned every  $5^{\circ}$  (azimuth angle) and a circular area with a diameter of 80 m was mapped. The accuracy of the method was studied by a repeated scanning survey from a depth of 7 m.

APPENDIX A

## CRUISE PARTICIPANTS

Name	Institution	Profession
Volkov, V.A.	AARI	Sen.Sci. Oceanography, Expedition Leader
Abramov, V.A.	AARI	Sen.Sci. Sea Ice
Kalyazin, V.E.	AARI	Scientist Oceanography
Norchenko, K.A.	AARI	Jr.Sci. Oceanography
Krivtsov, A.A.	AARI	Jr.Sci. Electronics
Vinje, T.	NPRI	Sen.Sci. Sea Ice
Johnsen, Å.S.	NPRI	Scientist Sea Ice
Østerhus, S.	NPRI	Scientist Oceanography
Østensen, Ø.	IMR	Scientist Oceanography

Abbreviations :

AARI = Arctic and Antarctic Research Institute,      Soviet  
 NPRI = Norwegian Polar Research Institute,      Norway  
 IMR = Institute of Marine Research,      Norway

APPENDIX B

FIGURES

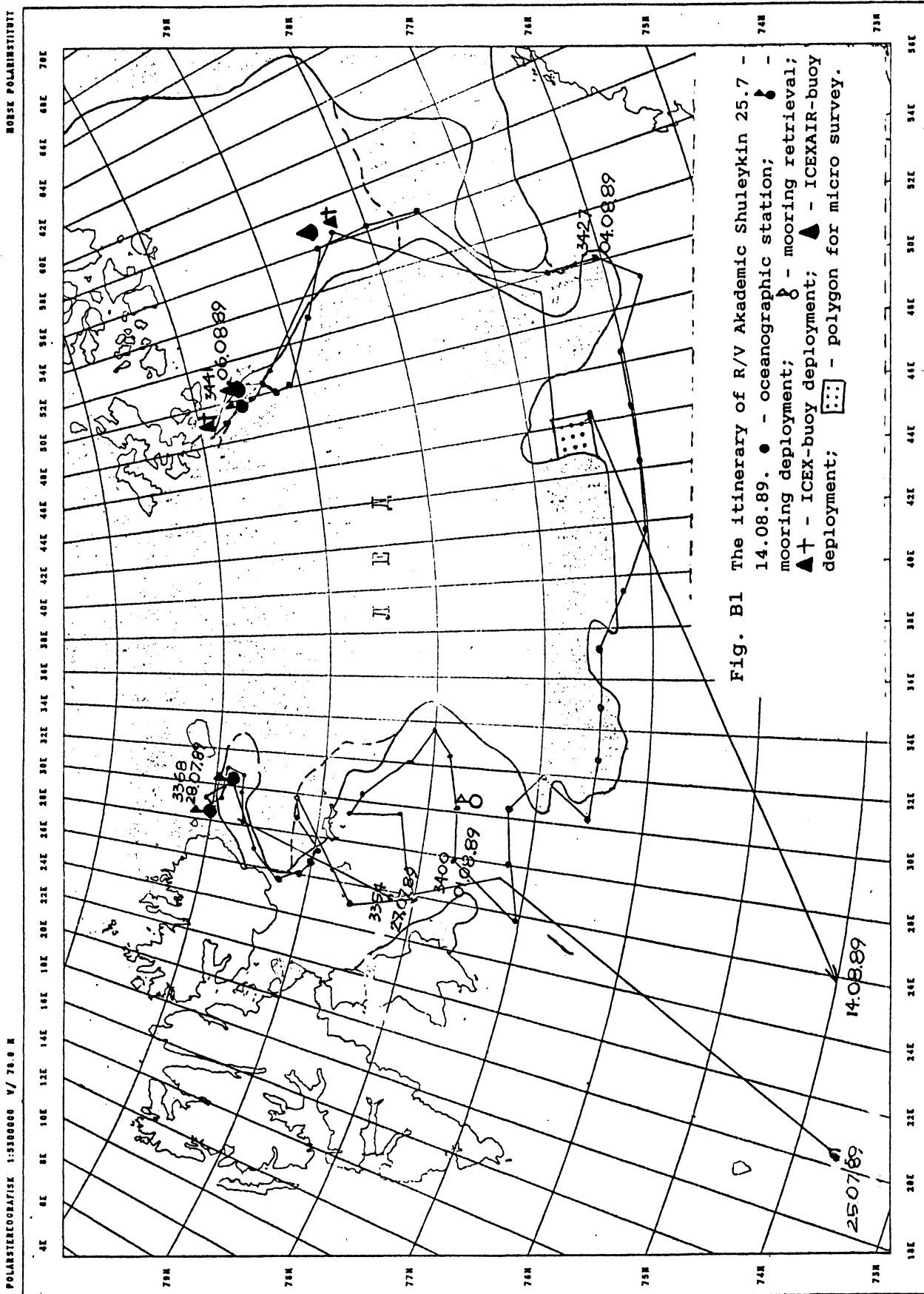

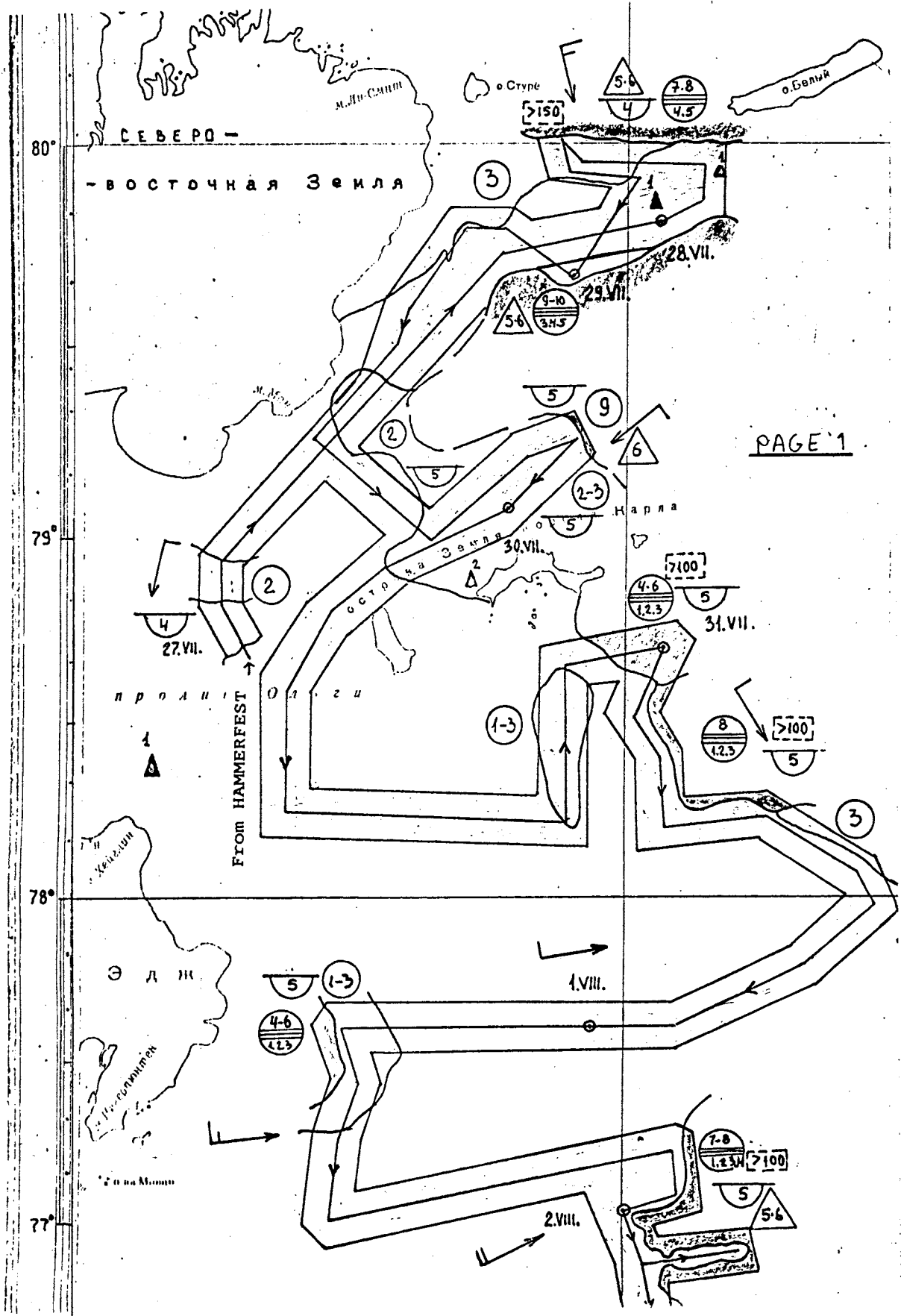

PAGE 1

FROM HAMMERFEST

80°

79°

78°

77°

СЕВЕР -  
ВОСТОЧНАЯ ЗЕМЛЯ

проливы  
Олга

Э Д И

остр. на Мюссе

остр. Ступе

остр. Большая

остр. Карла

остр. Земля

остр. Олга

28.VII.

29.VII.

30.VII.

31.VII.

1.VIII.

2.VIII.

5-6  
4

7-8  
4.5

3

9-10  
3.4.5

2

2-3

4

2

5

9

4-6  
1.2.3

5

1-3

8  
1.2.3

>100  
5

3

5

1-3

4-6  
1.2.3

7-8  
1.2.3

>100  
5

5-6

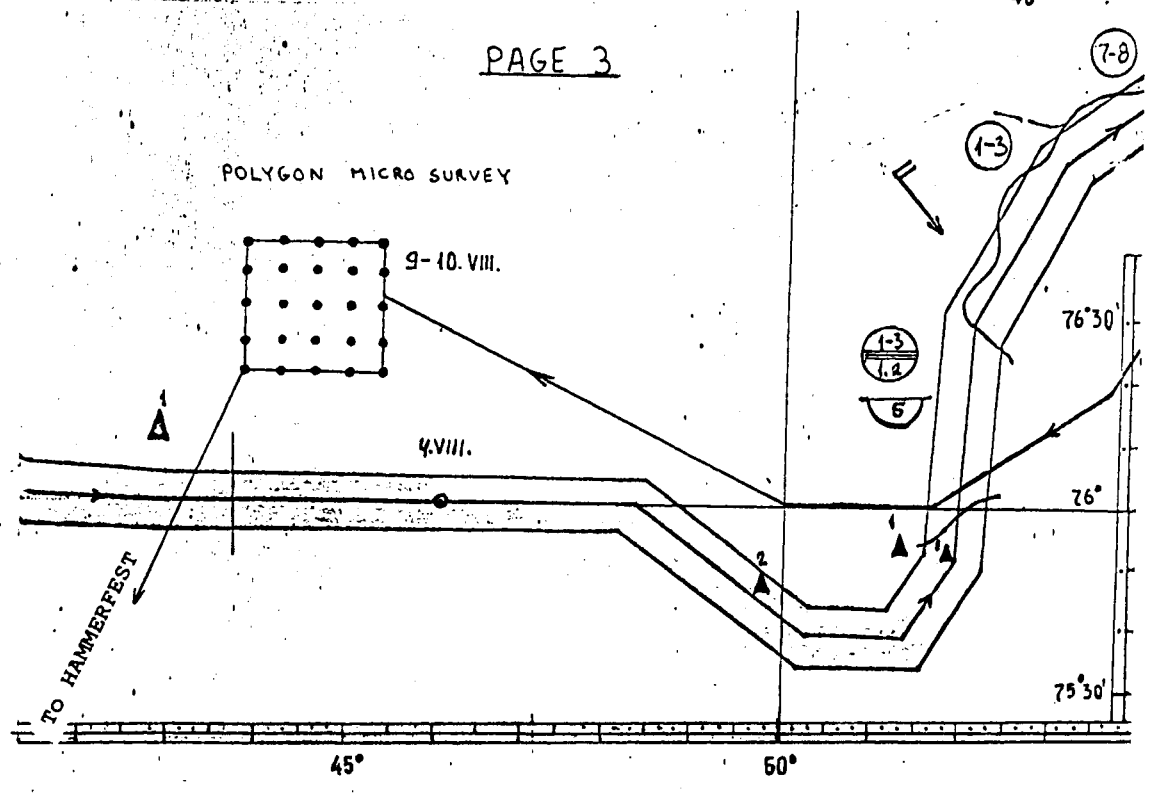
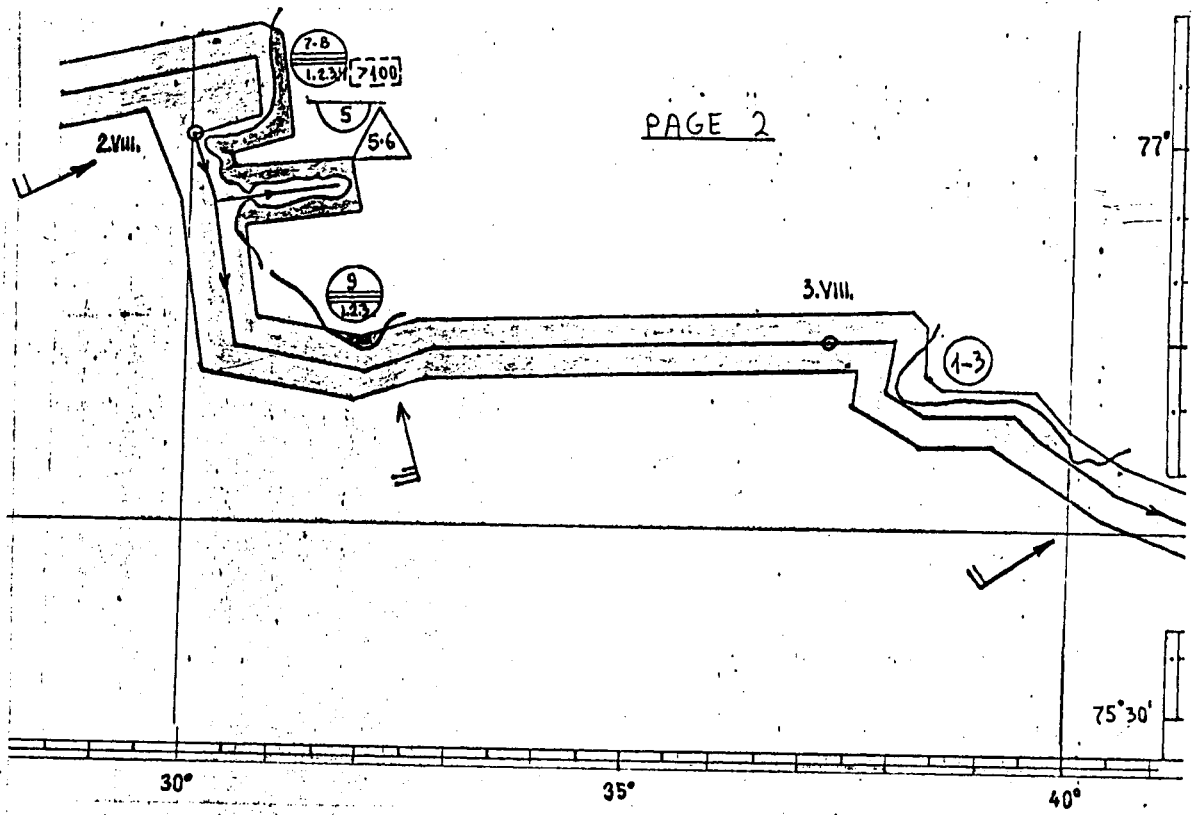

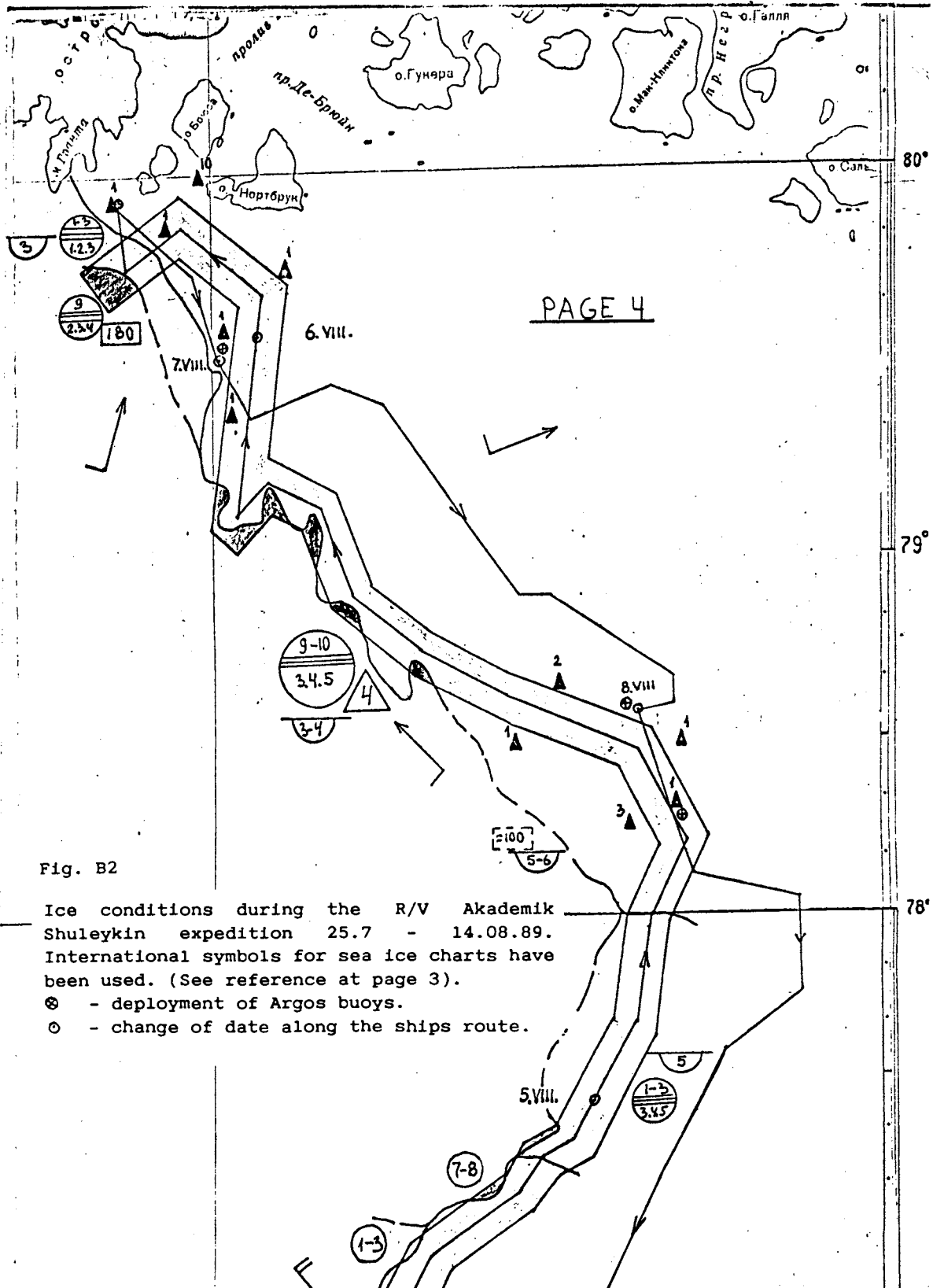

Fig. B2

Ice conditions during the R/V Akademik Shuleykin expedition 25.7 - 14.08.89. International symbols for sea ice charts have been used. (See reference at page 3).

- ⊗ - deployment of Argos buoys.
- - change of date along the ships route.

РОССИЙСКИЙ ПОЛЯРНИЙ ИНСТИТУТ

ПОЛЯРСТЕРОГРАФИК 1:300000 V/ 78.0 N

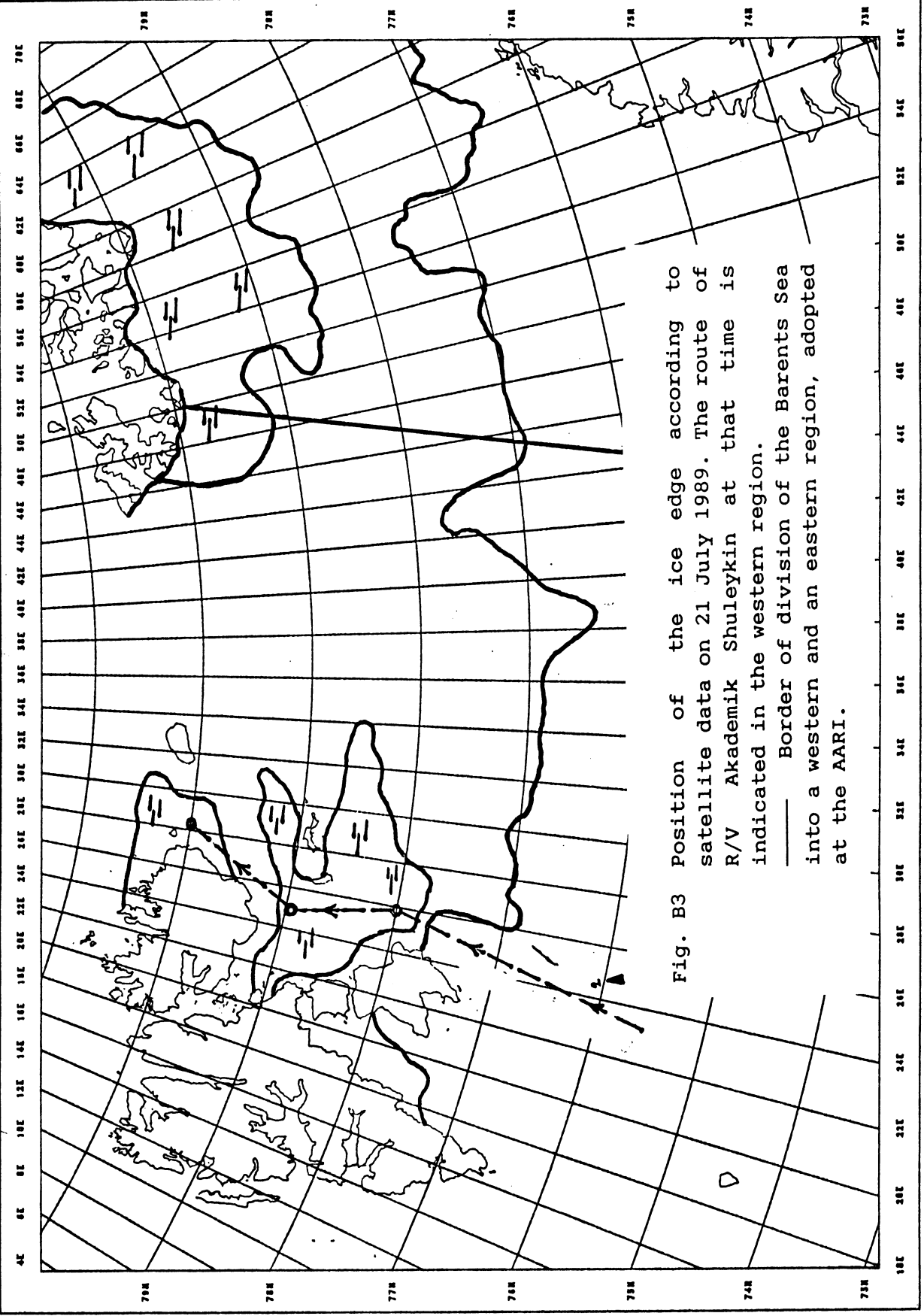

Fig. B3 Position of the ice edge according to satellite data on 21 July 1989. The route of R/V Akademik Shuleykin at that time is indicated in the western region.

— Border of division of the Barents Sea into a western and an eastern region, adopted at the AARI.

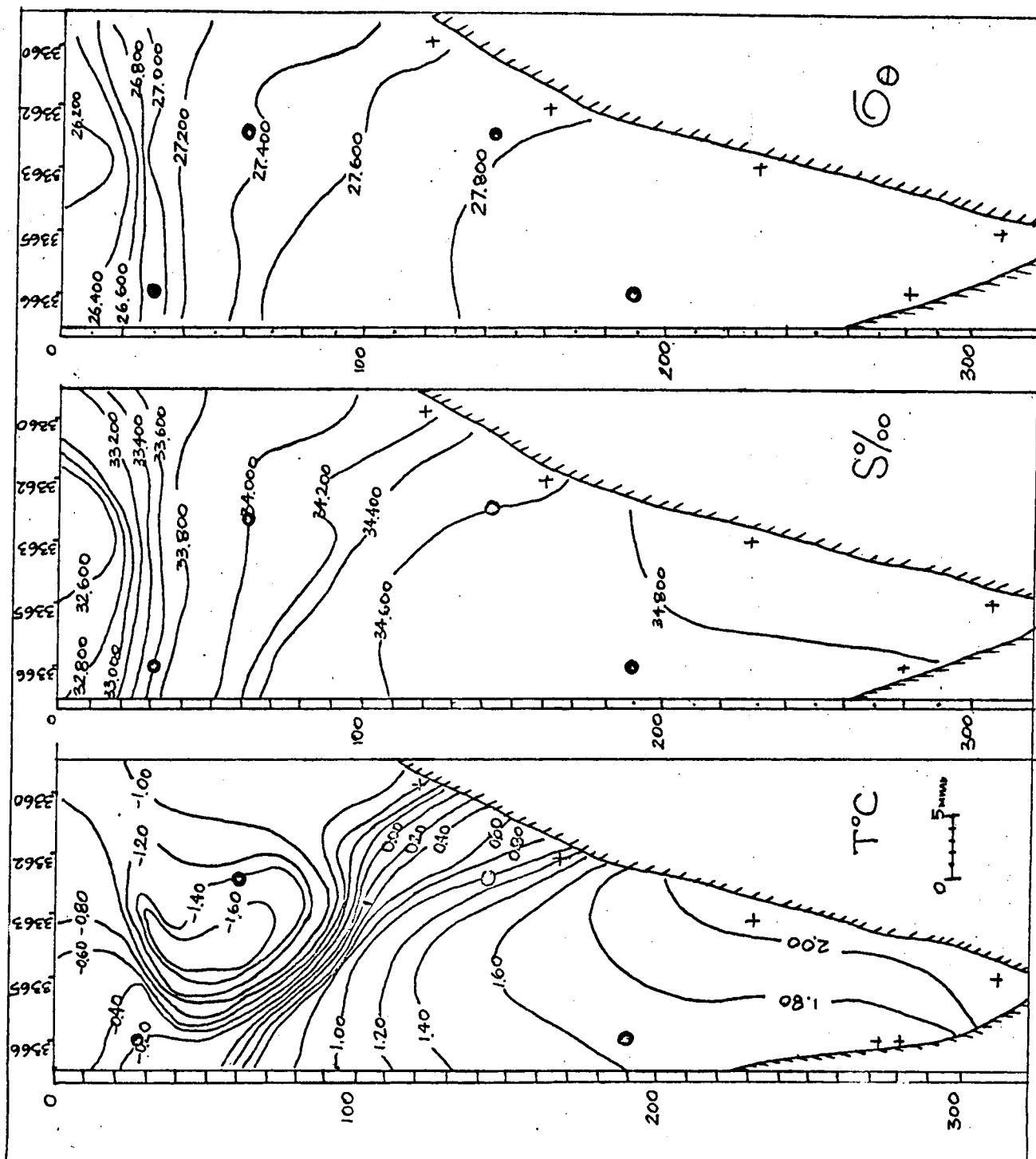

Fig. B4 Distribution of temperature, salinity, and density of water on the section Svalbard - Kvitøya. (End of July 1989).

Points show places of deployment of RCM-7 current meters.



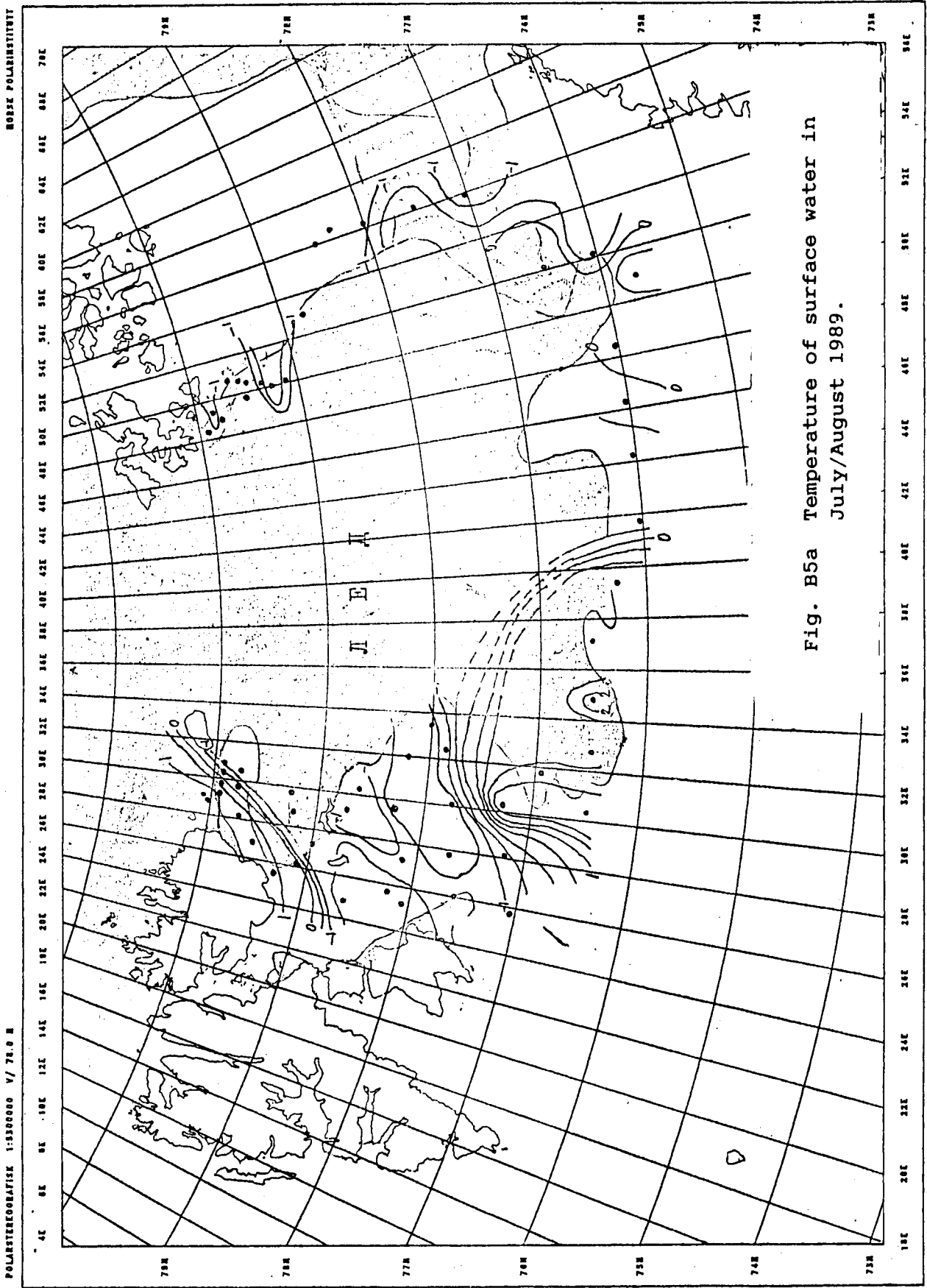

Fig. B5a Temperature of surface water in July/August 1989.

POLARSTEROGRAFIK 1:330000 V/ 74.0 N

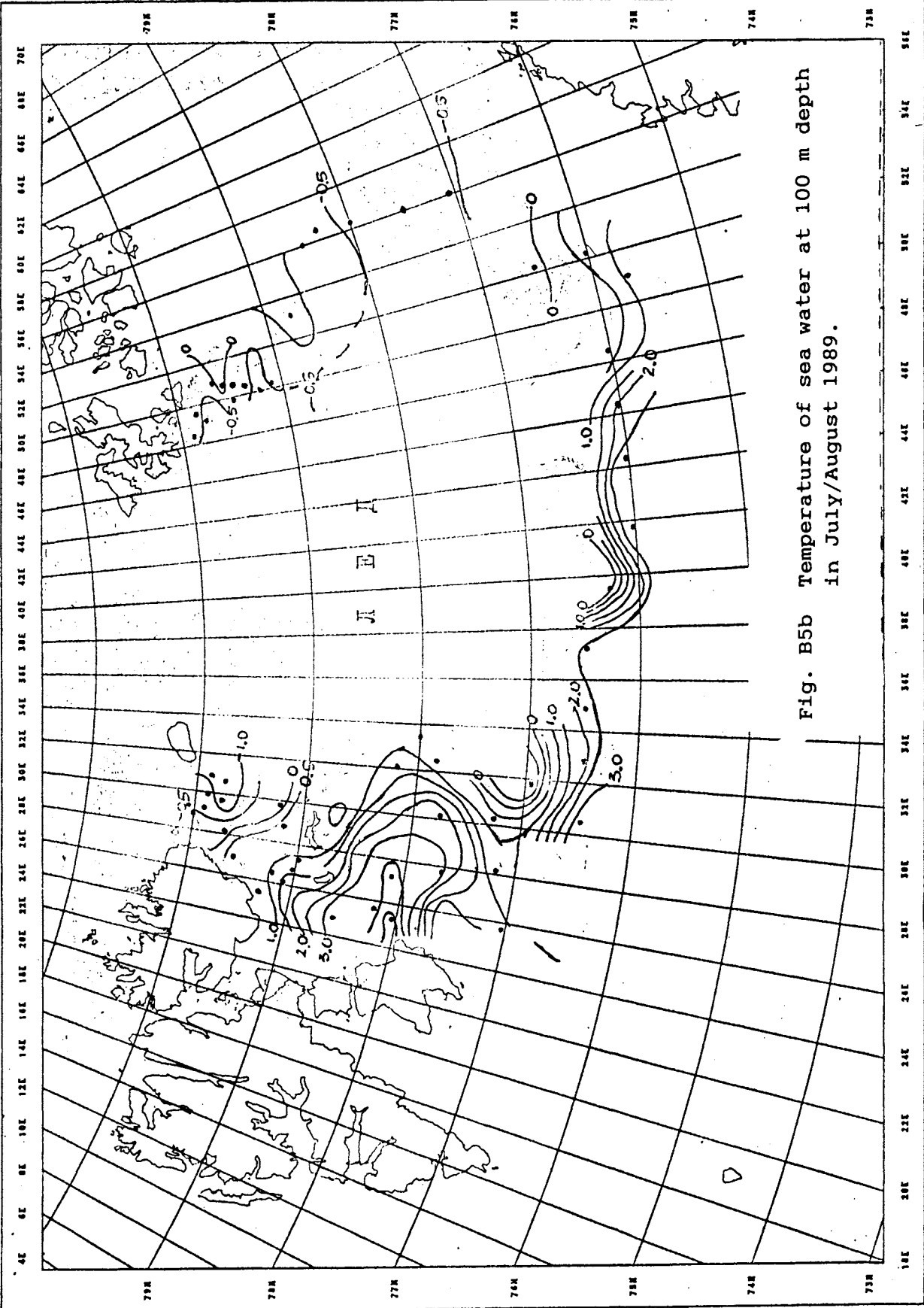

Fig. B5b Temperature of sea water at 100 m depth in July/August 1989.

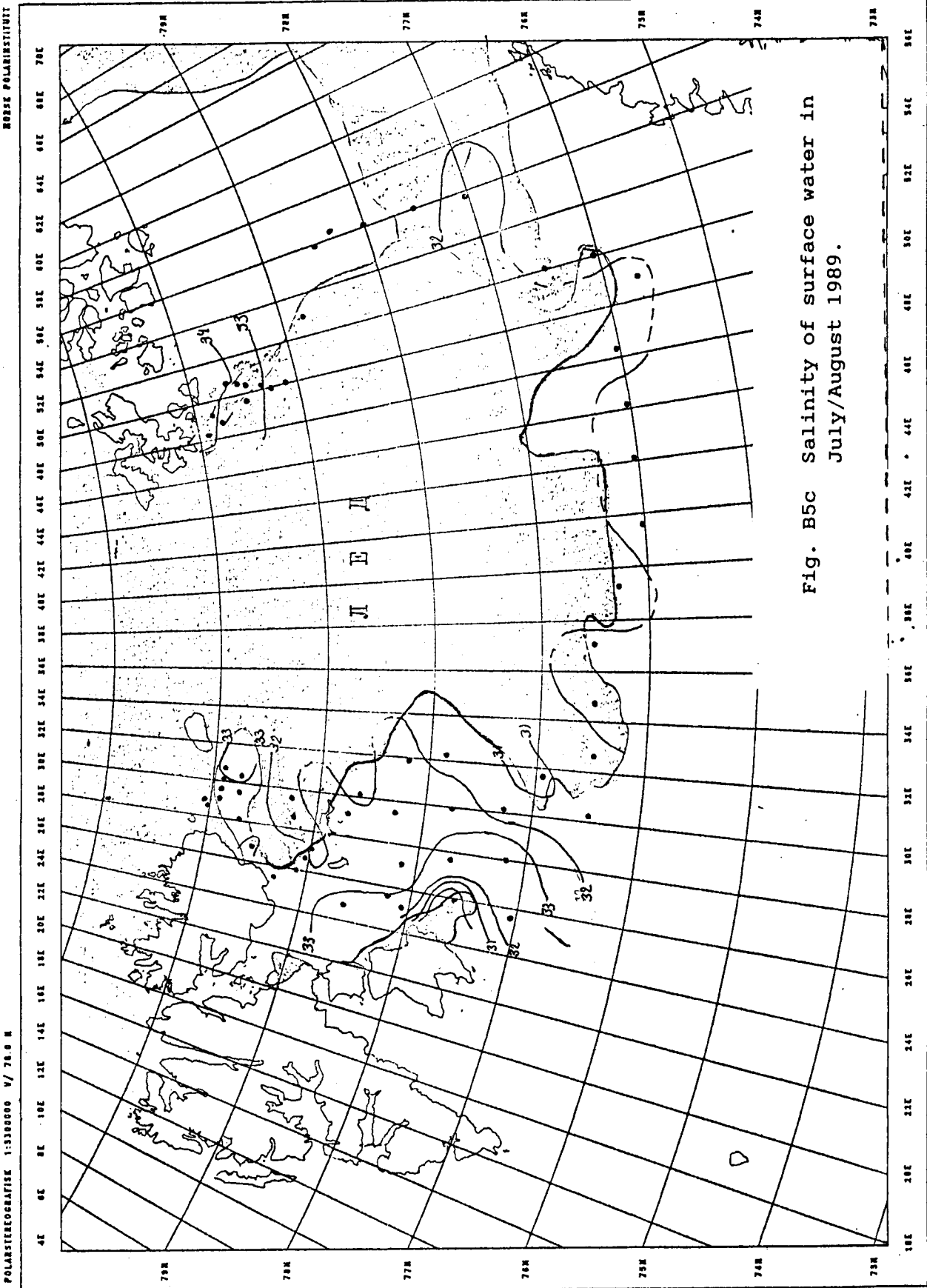

Fig. B5c Salinity of surface water in July/August 1989.

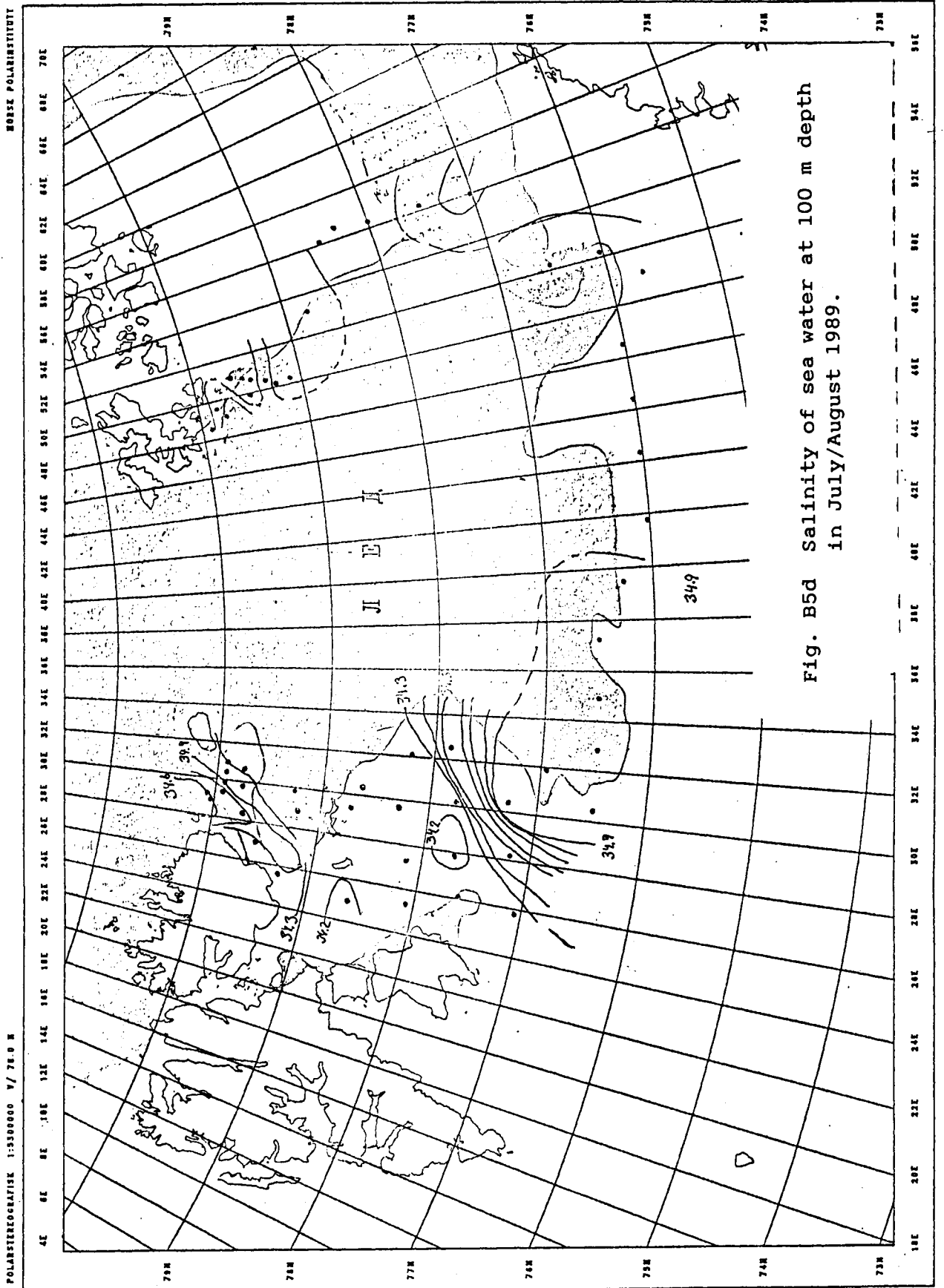
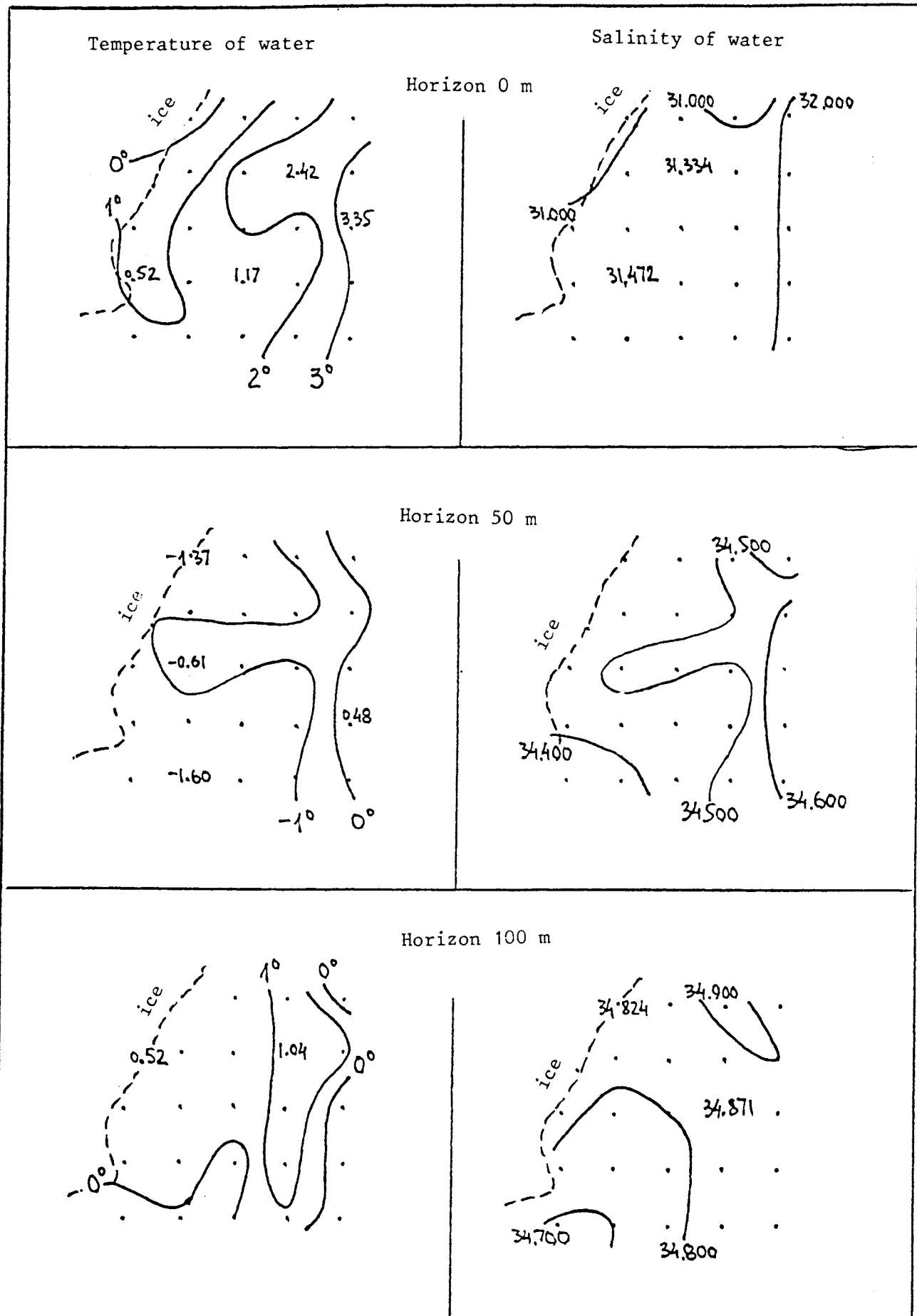

Fig. B5d Salinity of sea water at 100 m depth in July/August 1989.



**Fig. B6** Temperature and salinity of water in the polygon in the near-edge zone, in the Barents Sea 10-11. 08.89 (26th voyage of RV „Akademik Šulejkin“ SNOP)

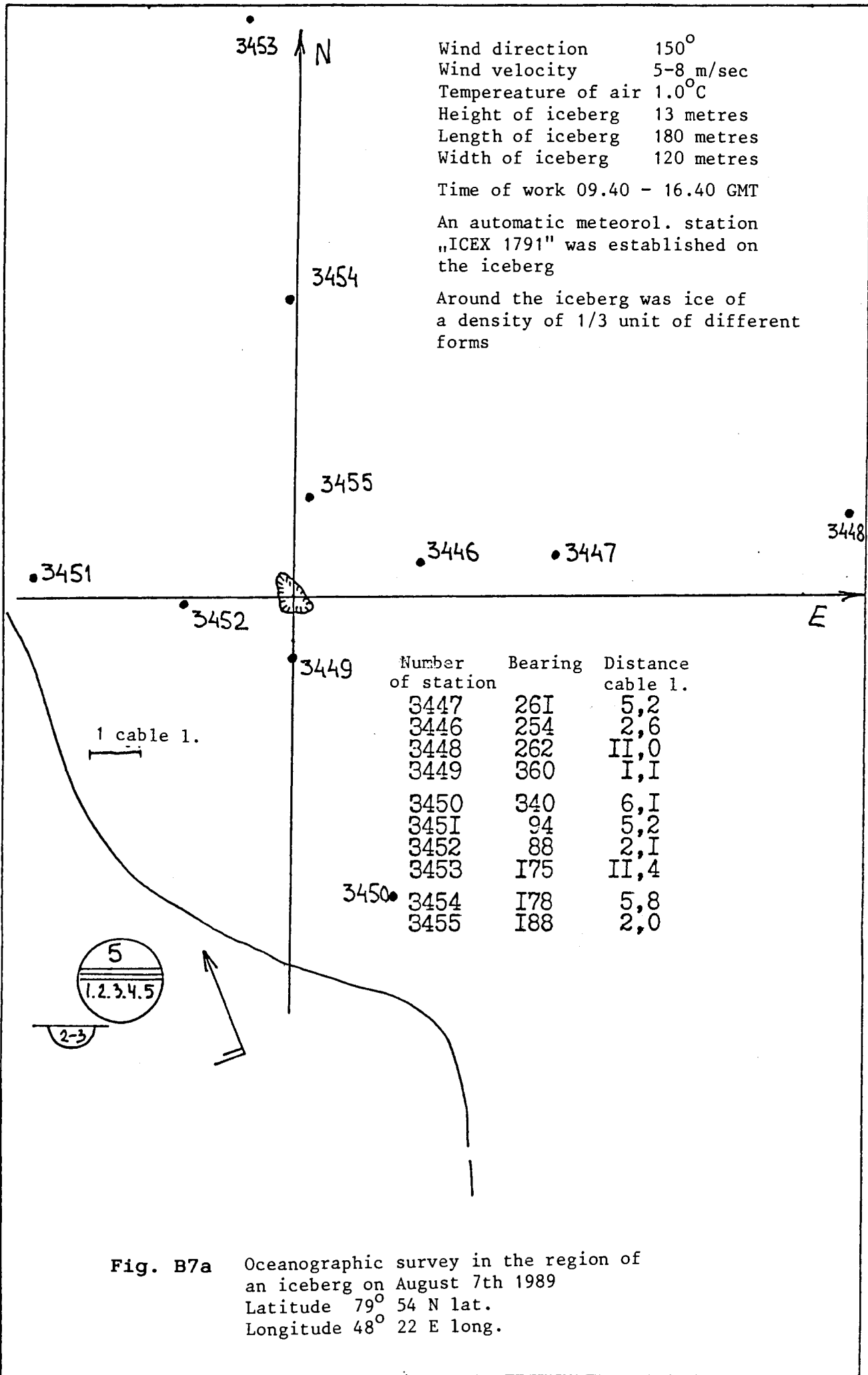

Fig. B7a Oceanographic survey in the region of an iceberg on August 7th 1989  
 Latitude 79° 54 N lat.  
 Longitude 48° 22 E long.

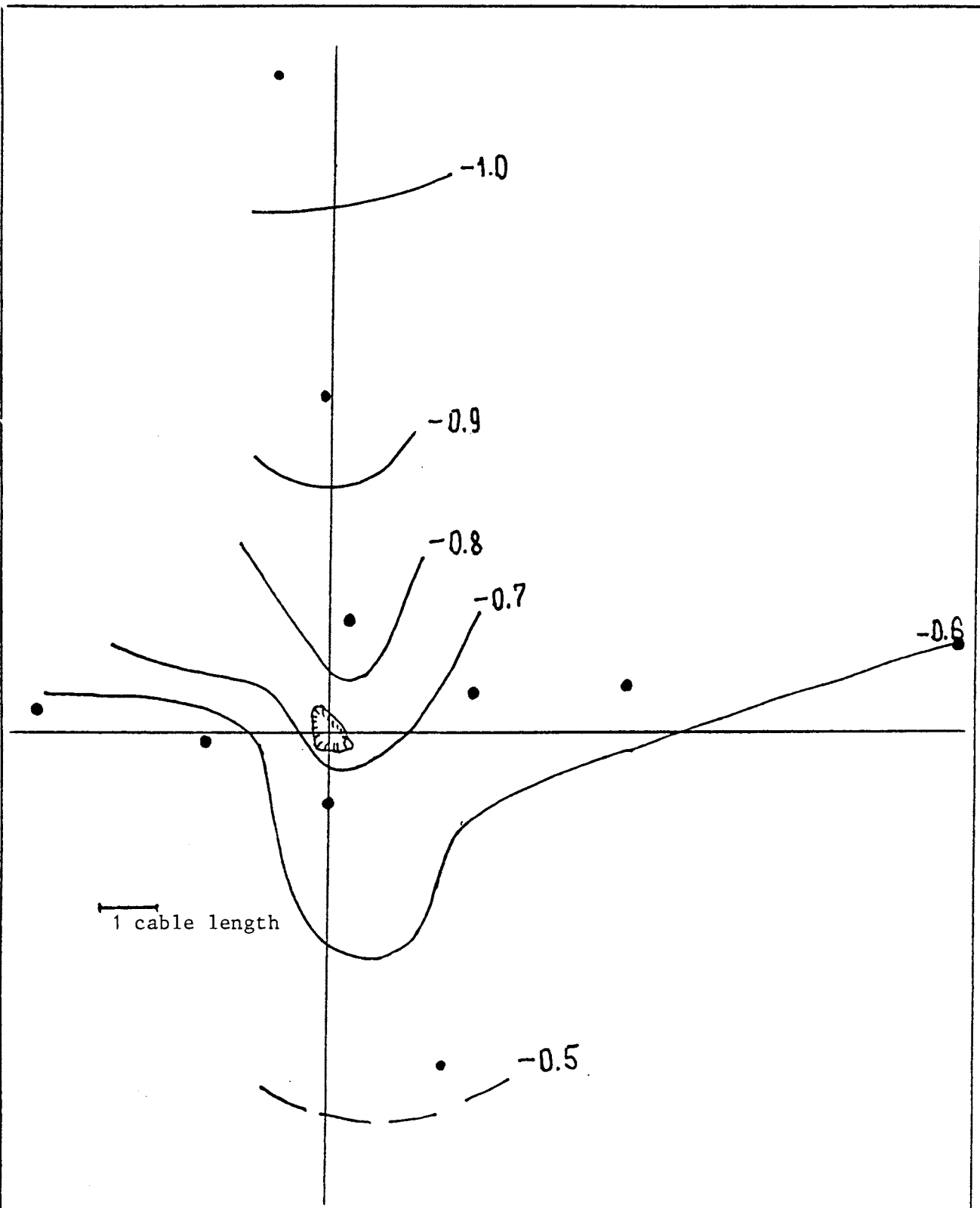

Fig. B7b Temperature of the water on the surface

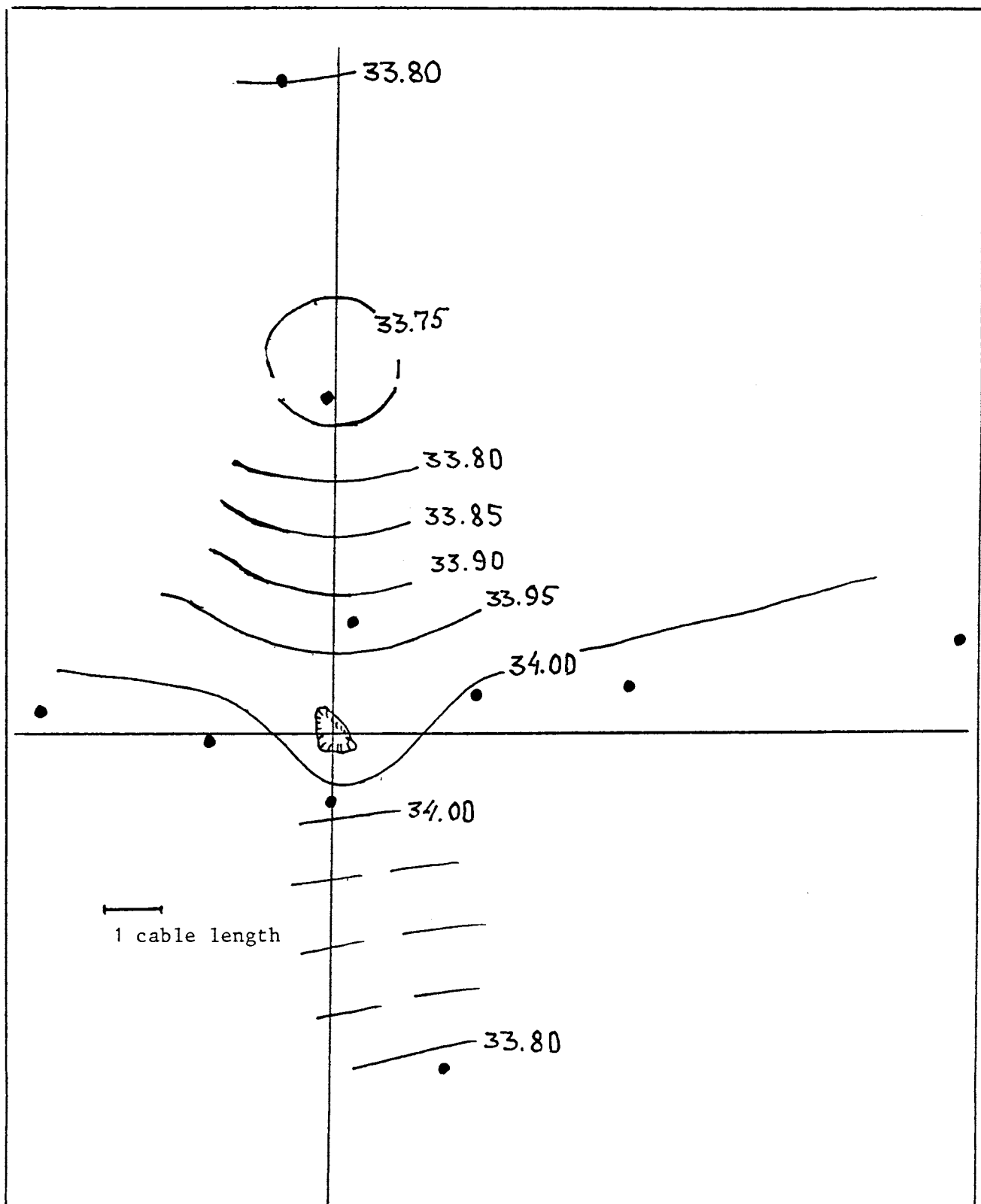

Fig. B7c Salinity of the water on the surface



### SNOP-89-03

Location: NORDAUSTLANDET/KVITÖYA CHANNEL-West (STORÖYA)

Position: 80° 01' N  
 28° 57' E  
 Depth: 205 m

Radar bearing: STORÖYA 288° 8.3 n.m.

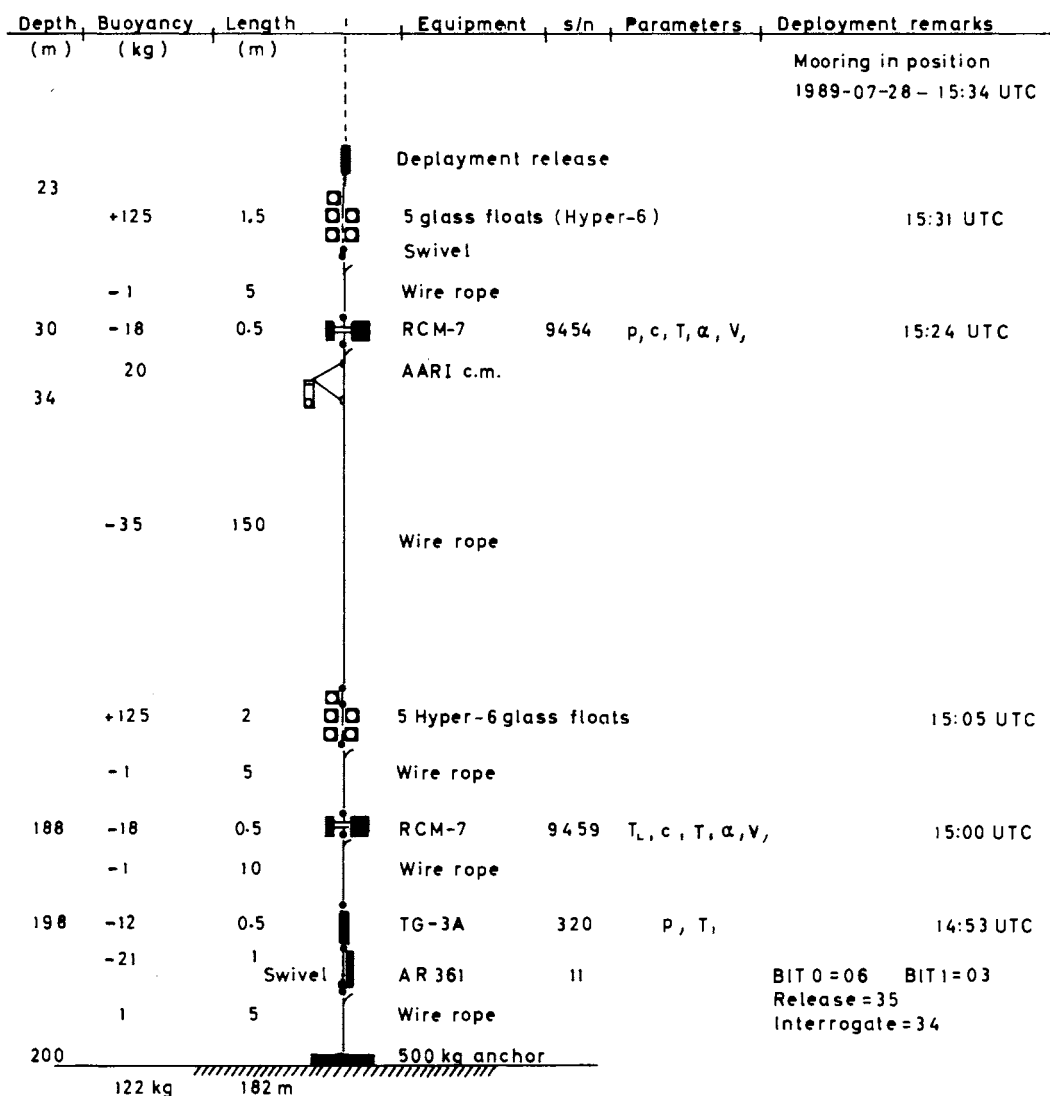

Fig. B8a Sketch of the mooring SNOP-89-03

## SNOP-89-04

Location: NORDAUSTLANDET/KVITÖYA CHANNEL-East (Andrèneset)

Position: 79°52'N  
30°12'E

Depth: 160m

Radar bearing: Andrèneset 46° 19 n.m.

Depth (m)	Buoyancy (kg)	Length (m)	Equipment	s/n	Parameters	Deployment remarks
						Mooring in position 1989-07-28 19:55 UTC
46	+35	1	Deployment release U.S. CMI:ES-300III 01			
	-1	5	Wire rope			
	+125	2.5	5 glass floats (Hyper-6)			
	-1	5	Swivel Wire rope			
60	-8	0.5	RCM 7	9455	p, c, T, α, V	
	-15	75 (50+25)	Wire rope			
	+125	2.0	5 glass floats (Hyper 6)			19:22 UTC
	-1	5	Wire rope			
142	-18	0.5	RCM-7	9460	c, T, α, V	19:13 UTC
	-2	10	Wire rope			
153	-12	0.5	TG-3A	321		19:05
	-21	1 Swivel 5	AR 361	7		
	-1		Wire rope			
160		1	500 kg anchor			
	+195 kg	114 m				BIT 0=06 BIT1=03 Release=21 Interrogate=22

Fig. B8b Sketch of the mooring SNOP-89-04

### SNOP-89-05

Location: South off ZEMLYA FRANTSO IOSIFA

Position: 79° 30,57' N } Sat. fix. 22:45 UTC  
 50° 04,64' E }

Depth: 323 m

Ref. CTD station 3457

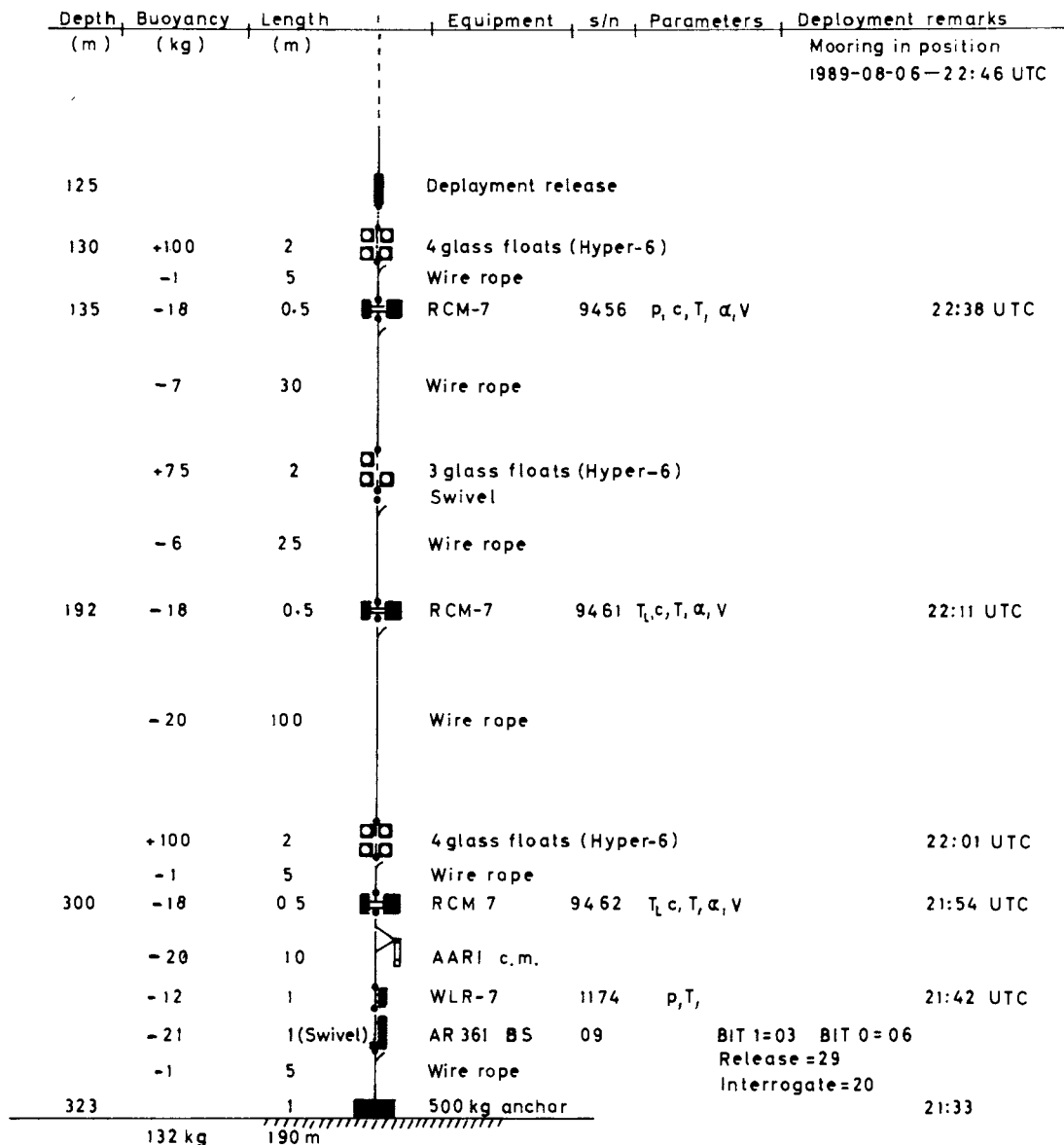
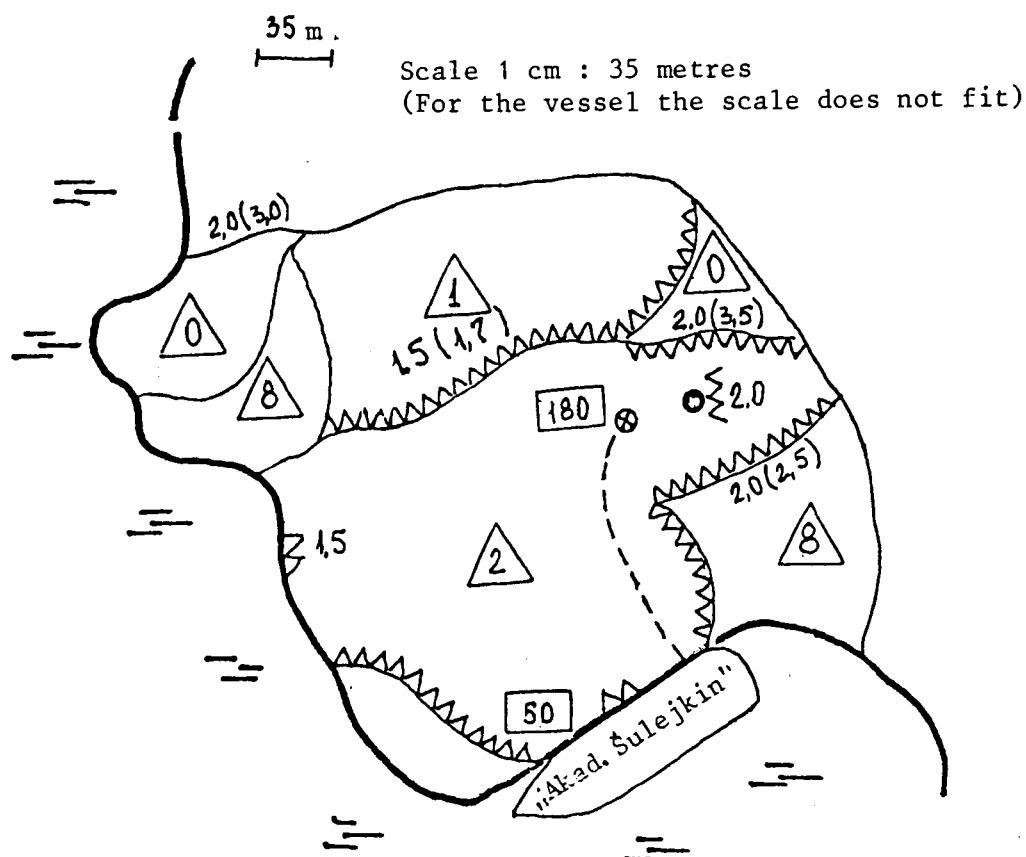

Fig. B8c Scetch of the mooring SNOP-89-05

## Coordinates

Initial	Final	Temperature of atmosphere	1.4°C
79°31 N lat.	79°34 N lat.	Temperature of water	-0.5°C
50°06 E long.	50°10 E long.	Direction of wind	215°
		Velocity of wind	6 m/sec

Duration of work: three hours and thirty minutes



- Position of buoy No 1892 on the ice floe
- ⊗ Position of the sonar for survey of the lower surface of ice of a radius of 40 metres
- - - position of cable on the ice floe

Thickness of snow on even ice - 5 cm: on hummocks up to 50 cm wet snow, thin ice, state of demolition - 4 units  
(1.5(1.7) - height of hummocks in metres characteristic (maximum))

Fig. B9 Sketch of the ice surface of a part of the floe where buoy 1892 was deployed and the bottom topography was surveyed.

TORGNY VINJE

# CRUISE REPORT

R/V LANCE

23 AUGUST - 17 SEPTEMBER 1989



**TABLE OF CONTENT**

	Page
PROGRAMME SCHEDULE .....	1
SEA ICE .....	3
OCEANOGRAPHY .....	5
APPENDIX A : CRUISE PARTICIPANTS .....	A1
APPENDIX B : FIGURES .....	B1
APPENDIX C : TABLES .....	C1

## PROGRAMME SCHEDULE

The cruise with R/V LANCE arranged by Norsk Polarinstitutt between 23 August and 17 September 1989 (fig. B1, Appendix B) concerned sea ice work and oceanography in the Barents Sea and the Fram Strait. The programme were part of the Soviet Norwegian Oceanographic Programme (SNOP) with emphasis on the study and monitoring of water and sea ice exchange through the straits between Zemlya Frantsa Iosifa and Greenland.

In addition to detailed ice field characterization along the route, the sea ice work consisted of mapping of the top and bottom surfaces of icefloes, radar reflectivity measurements, chemical ice properties and surface melting. Altogether 9 icefloes were mapped and there was a total of 11 ice stations.

The oceanographic data were obtained from CTD measurements with a total of 152 CTD casts.

Meteorological observations were performed by the ships officers every 3 hours according to the international WMO ship code and transmitted to the Norwegian Meteorological Office for further dispatch.

The heavy sea ice conditions this year with large content of multi-year floes, limited our plans. We wanted to make CTD cross sections in the Fram Strait, but were unable to go more than a few nautical miles into the pack ice. We had also planned to deploy a mooring north of Spitsbergen, but we could not reach the necessary latitude. A map of the sea ice distribution is plotted in figure B2 (Appendix B). The plot is in the standard EGG code.

### Field work

R/V LANCE started out from Bodø 23 August 1989. Scientific personnel were picked up in Tromsø 24 August and equipment left from the last SNOP expedition with R/V AKADEMIK SHULEYKIN were reloaded in Hammerfest 25 August.

On our way north, we tried to recover four automatic iceberg buoys that had fallen off the icebergs and were drifting in the sea. Due to old positions (weekend) and waves, we only managed to recover one of the buoys.

Our next mission were to recover a mooring that were deployed from LANCE last September. Another research wessel had

unsuccessfully tried to recover it 14 days earlier. They got contact with release unit, but the mooring did not come up when they tried to release it. After this, they were unable to get any new contact. We failed also in getting contact with the release unit, and spent several hours to search for the mooring using both grapnels and side scanning sonar. The sonar signals indicated that the mooring anchor was left at the bottom, but there was no sign of the mooring. We then assumed that the mooring were released 14 days earlier and was drifting below the surface. On the 2 September we searched southward in the presumed direction of the drift of the mooring with negative result.

From 28 August to 4 September we took 79 CTD casts in the north-western part of the Barents Sea and 5 ice stations. From 5 September to 13 September we took 73 CTD casts in the Fram Strait and 6 ice stations.

13 September T. Vinje and Å.S. Johnsen left the vessel in Ny Ålesund to calibrate the NP radiation instruments.

R/V LANCE left Ny Ålesund the next day and headed for Tromsø. Two persons from Sjøkartverket had then boarded the ship and on the way south there was a search for another missing mooring owned by Sjøkartverket. The use of a new GPGS positioning system proved to be very successful, and the mooring was grappled on 16 September.

The ship arrived Tromsø 17 September.



## SEA ICE

A.S. Johnsen and M. Kristensen

The sea ice investigations consisted of 10 different research programs :

- 1) Bottom topography mapping of sea ice using a scanning sonar, Mesotech 971.
- 2) Surface topography mapping of sea ice using a theodolite. Mapping of the same area as in 1).
- 3) Ice core samples were melted and put on small bottles. They were sent to Iceland to get an isotope analysis of  $O_{16}/O_{18}$  and deuterium. The salinity was measured from the excess water with a portable salinometer.
- 4) Reflectivity measurements were taken from different ice/snow surfaces using a portable MSSL Mk.2 13.5 GHz radar.
- 5) Surface samples of snow and ice were collected for later analysis in a mass spectrometer to find radioactive material.
- 6) Drift of the ice floe during the ice station.
- 7) Water in the core hole. The salinity of the water flushing the drilling hole was measured every 50 cm through the ice.

Table 1 on the next page gives a brief overview of when and where the sea ice work was done. Programme 1, 2 and 4 were the main activities, and most time was spent on this programmes.

Figure B3 (Appendix B) shows a map with the ice stations where programme 1 and 2 were done. The numbers refer to the ice floe number of ice floes mapped by the sonar (table 1).

Table 1 Key table to the sea ice work during the expedition.  
The columns marked 1 through 7 is referring to the scientific programmes described in the text.

St = Station number

Nr = Icefloe number (mapped by sonar)

St	Nr	Date	Lat	Long	1	2	3	4	5	6	7
1	45	29 Aug	79° 13 'N	31° 19 'E	X	X	X	X	X	X	
2	46	30 Aug	79° 45 'N	30° 09 'E	X	X	X	X	X	X	
3	47	30 Aug	79° 17 'N	30° 17 'E	X	X	X	X	X	X	
4	48	1 Sep	78° 49 'N	29° 32 'E	X	X	X	X	X	X	
5	49	4 Sep	79° 01 'N	23° 40 'E	X	X	X	X	X	X	X
6		6 Sep	80° 40 'N	17° 09 'E			X		X		X
7	50	7 Sep	80° 33 'N	11° 14 'E	X	X	X	X	X		
8		8 Sep	80° 08 'N	2° 54 'E							X
9	51	11 Sep	78° 28 'N	1° 51 'W	X	X	X	X	X	X	
10	52	11 Sep	78° 26 'N	1° 55 'W	X	X					
11	53	11 Sep	78° 46 'N	0° 52 'W	X	X	X	X	X	X	

## OCEANOGRAPHY

### S. Østerhus

A Neil Brown NBIS-CTD was used to measure temperature and salinity. The instrument worked without problems throughout the whole cruise.

79 CTD casts were taken in the NW-Barents Sea, all to the bottom. 73 casts were taken in the Fram Strait and to the west of Svalbard. Max depth of measure was 1200 metres due to breakdown of one of the CTD winches. The positions of the CTD stations are plotted in figure B4 (Appendix B), and the positions, time and dept data are shown in table C1 (Appendix C).

The temperature and pressure sensors were calibrated after the cruise. No deviations were noted. The conductivity cell was calibrated by means of water samples from a Nansen bottle mounted about 1 metre above the CTD.

APPENDIX A

## CRUISE PARTICIPANTS

Name	Institution	Profession
Vinje, T.	NPRI	Scientist Sea Ice Expedition Leader
Johnsen, A.S.	NPRI	Scientist Sea Ice
Kristensen, M.	DNMI	Scientist Sea Ice
Hansen, B.	NPRI	Assistant Sea Ice
Riiser, J-M.	NPRI	Assistant Sea Ice
Østerhus, S.	NPRI	Scientist Oceanography
Orvik, K.	UB	Scientist Oceanography
Pavlov, V.K.	AARI	Scientist Oceanography
Doronin, N.Yu.	AARI	Scientist Oceanography
Lebedev, P.	AARI/M	Scientist Oceanography

Abbreviations :

NPRI = Norwegian Polar Research Institute, Norway  
 DNMI = The Norwegian Meteorological Institute, Norway  
 UB = University of Bergen, Geophysical Inst., Norway  
 AARI = Arctic and Antarctic Research Institute, Soviet  
 AARI/M = AARI, Division Murmansk, Soviet

## APPENDIX B

## FIGURES

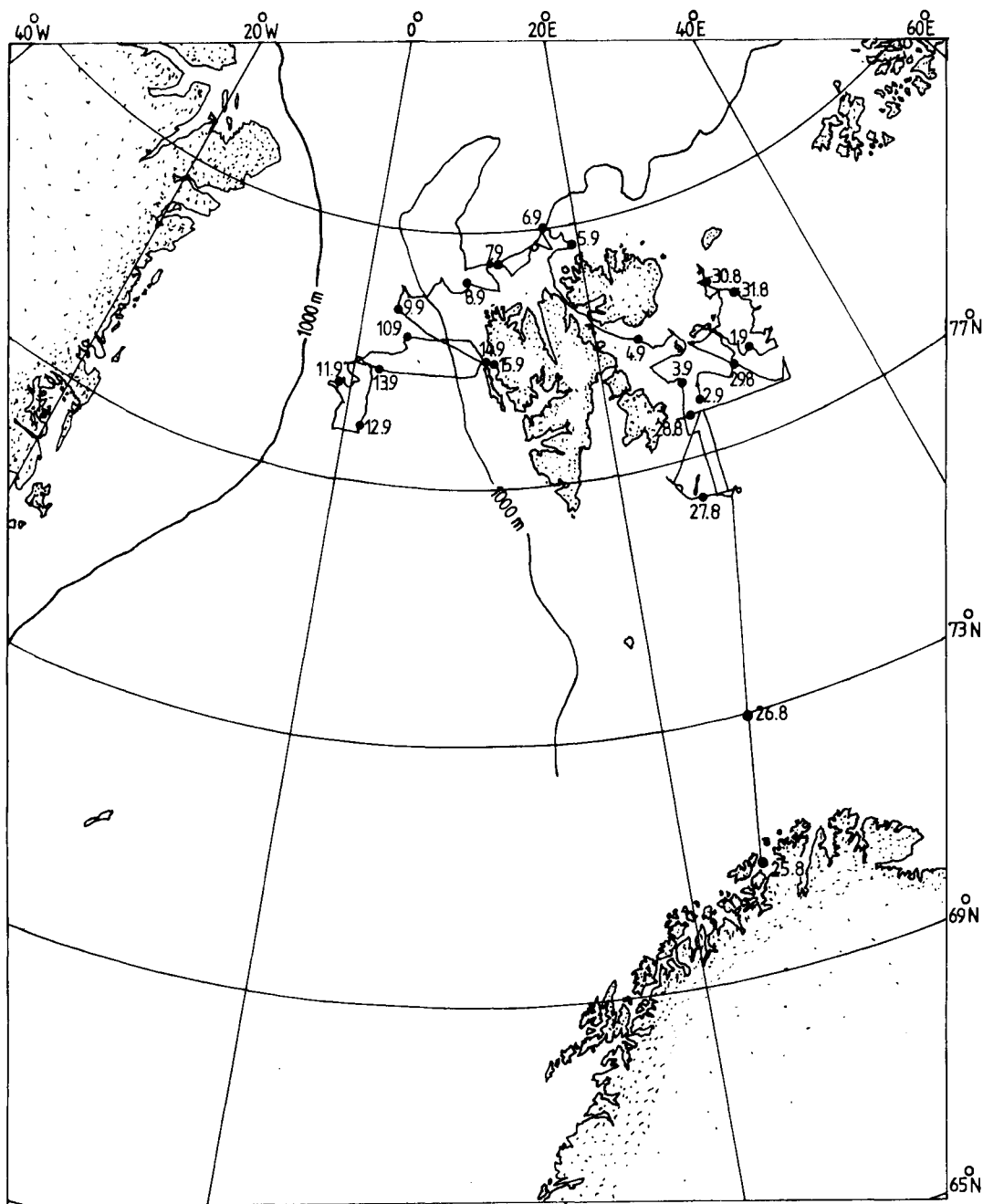
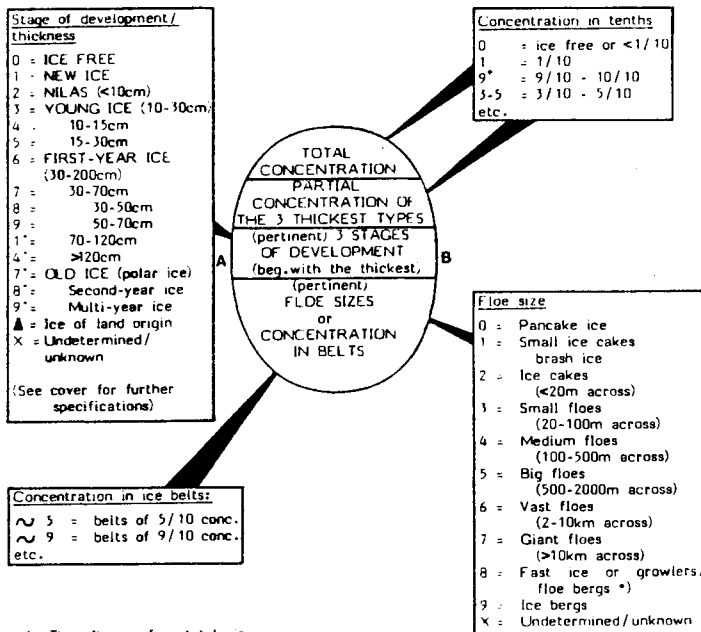

Fig. B1 Cruise route of R/V LANCE from 25 August to 15 September 1989.

1. EGG SYMBOL



Note: The figure for total ice concentration may not include new ice.

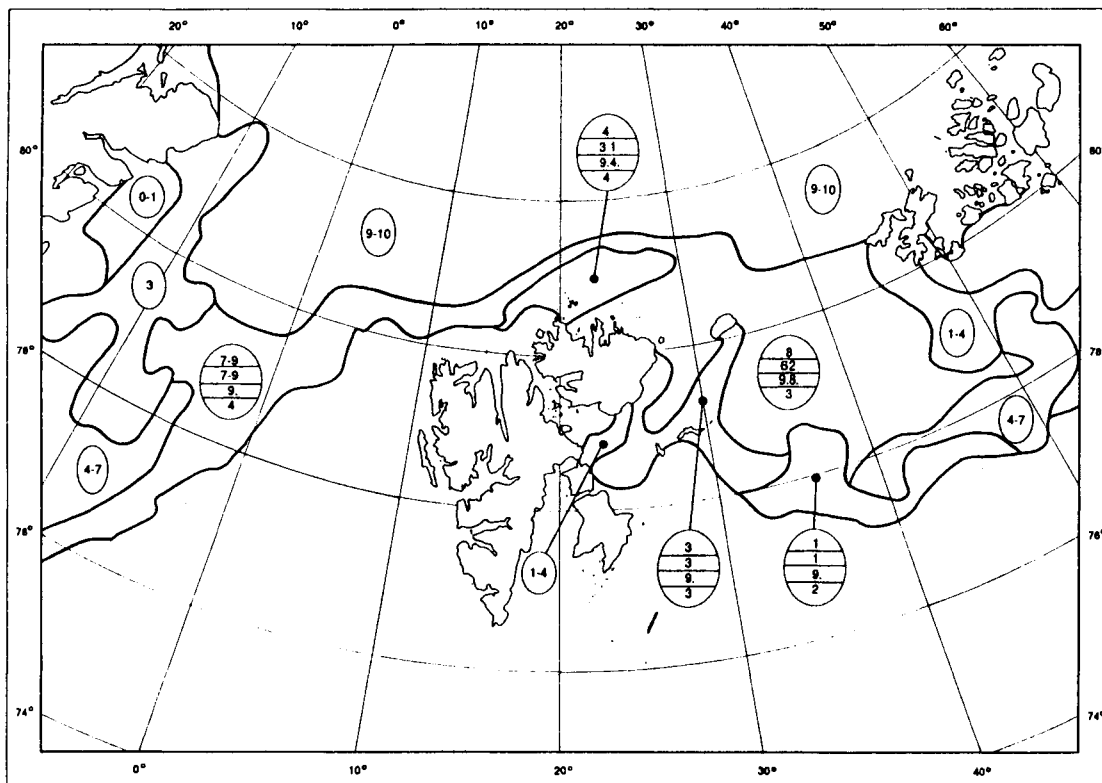

Fig. B2 Sea ice conditions during the R/V LANCE expedition in August/September 1989. The numbers refer to the EGG code for sea ice.

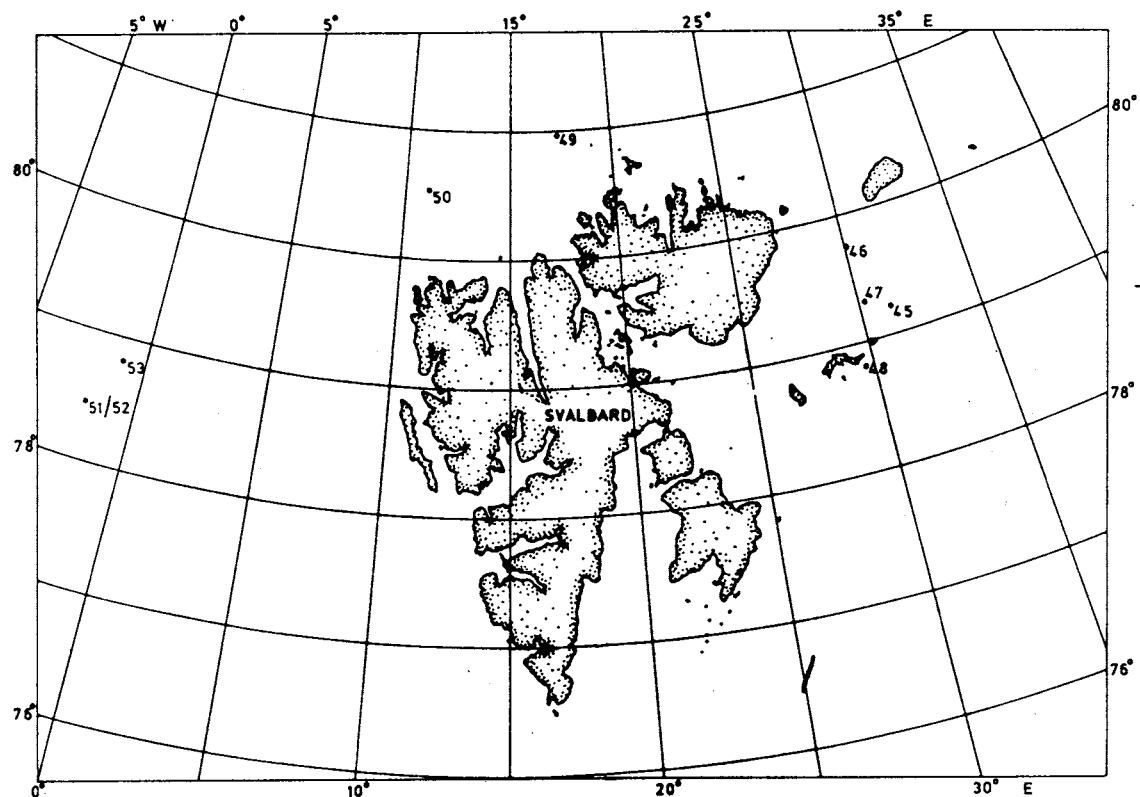

Fig. B3 Ice floes mapped by sonar during the R/V LANCE expedition in August/September 1989. See also table 1.

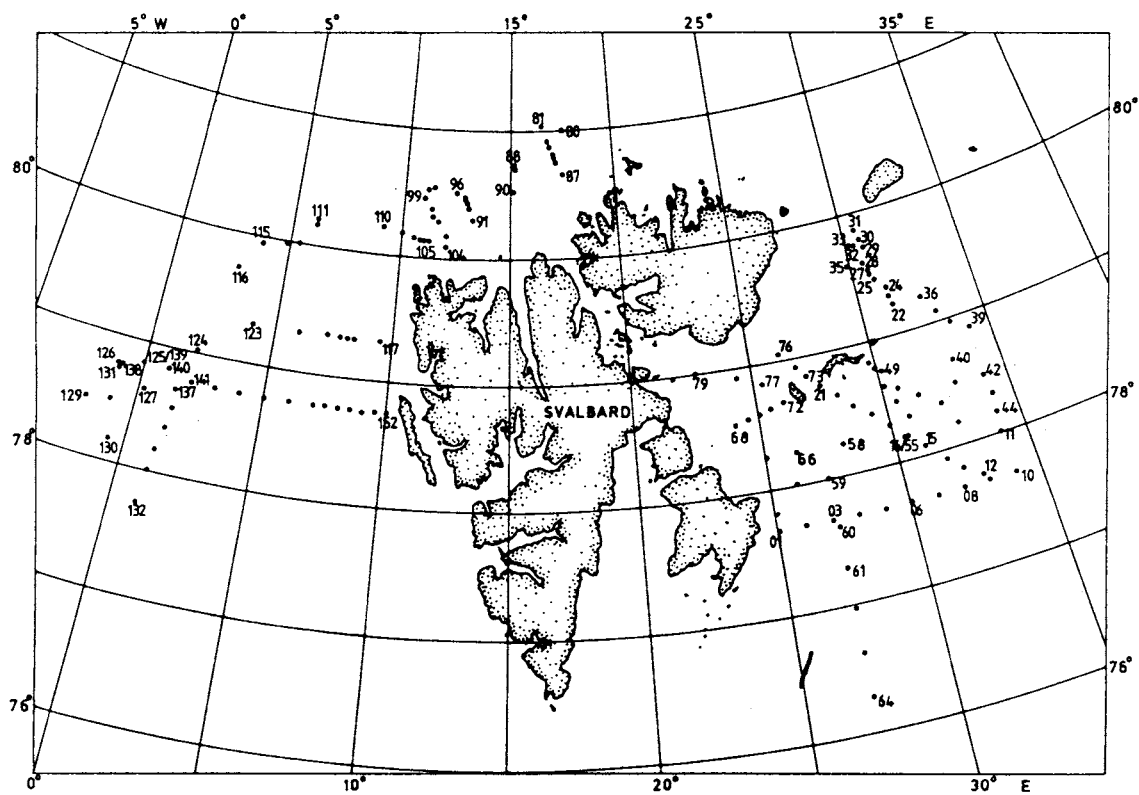

Fig. B4 CTD casts during the R/V LANCE expedition in August/September 1989. See also table C1.

APPENDIX C

## TABLES

Table C1 List of position, time, and depth of the CTD-stations during the cruise.

STA	POSITION	TIME	BOTTOM DEPTH	MIN OBS	MAX OBS
1	77.3970 N 25.0100 E	89: 8:28: 140	113	2	104
2	77.4010 N 26.0020 E	89: 8:28: 318	178	2	168
3	77.4000 N 27.0000 E	89: 8:28: 450	126	2	118
4	77.4020 N 28.0000 E	89: 8:28: 6 2	175	2	164
5	77.3990 N 29.0040 E	89: 8:28: 724	207	2	194
6	77.3990 N 30.0000 E	89: 8:28: 853	212	2	230
7	77.4000 N 31.0060 E	89: 8:28:1025	216	2	204
8	77.3990 N 32.0000 E	89: 8:28:1143	135	2	132
9	77.4000 N 33.0000 E	89: 8:28:1257	137	2	124
10	77.4000 N 34.0000 E	89: 8:28:14 8	176	2	164
11	78.0000 N 34.0000 E	89: 8:28:1619	223	2	210
12	77.4340 N 32.4980 E	89: 8:28:19 7	153	2	144
13	77.4880 N 32.1270 E	89: 8:28:2024	127	2	116
14	77.5710 N 31.4040 E	89: 8:28:2137	226	2	214
15	78.0400 N 31.0330 E	89: 8:28:2244	236	2	216
16	78.1100 N 30.2900 E	89: 8:28:2350	268	2	256
17	78.1800 N 29.5460 E	89: 8:29: 1 2	327	2	314
18	78.2510 N 29.1920 E	89: 8:29: 212	296	2	284
19	78.3110 N 28.4010 E	89: 8:29: 317	278	2	264
20	78.3780 N 28.0920 E	89: 8:29: 415	132	2	122
21	78.4410 N 27.3450 E	89: 8:29: 512	127	2	116
22	79.1350 N 31.1880 E	89: 8:29:1815	135	2	124
23	79.1800 N 31.1290 E	89: 8:29:1947	230	2	242
24	79.2220 N 31.1340 E	89: 8:29:2055	270	2	266
25	79.2700 N 30.4980 E	89: 8:29:22 2	320	2	308
26	79.2980 N 30.4050 E	89: 8:29:23 0	175	2	166
27	79.3190 N 30.4010 E	89: 8:29:2338	75	2	70
28	79.3580 N 30.3010 E	89: 8:30: 115	55	2	48
29	79.4280 N 30.4420 E	89: 8:30: 220	83	2	74
30	79.4700 N 30.3840 E	89: 8:30: 330	64	2	62
31	79.5140 N 30.3000 E	89: 8:30: 450	81	2	70
32	79.4460 N 30.1840 E	89: 8:30: 632	203	2	192
33	79.4530 N 30.0780 E	89: 8:30: 930	187	2	180
34	79.3590 N 30.2960 E	89: 8:30:1230	85	2	78
35	79.3610 N 29.4940 E	89: 8:30:1343	280	2	270
36	79.1300 N 32.3000 E	89: 8:31: 011	122	2	112
37	79.0470 N 32.5850 E	89: 8:31: 241	176	2	168
38	78.5790 N 33.2460 E	89: 8:31: 4 5	249	2	236
39	78.5270 N 34.0580 E	89: 8:31: 639	295	2	282
40	78.4000 N 33.0100 E	89: 8:31:10 0	288	2	282
41	78.2960 N 32.5170 E	89: 8:31:1349	230	2	218
42	78.2850 N 34.0020 E	89: 8:31:1614	186	2	174
43	78.1880 N 34.0670 E	89: 8:31:1933	126	2	112
44	78.0990 N 34.0290 E	89: 8:31:2030	192	2	180
45	78.1020 N 32.3090 E	89: 8:31:2217	197	2	188
46	78.2130 N 32.0480 E	89: 8:31:2341	222	2	208
47	78.2850 N 31.1910 E	89: 9: 1: 213	298	2	284
48	78.3430 N 30.3590 E	89: 9: 1: 331	295	2	282
49	78.4430 N 30.0730 E	89: 9: 1: 525	145	2	138
50	78.4960 N 29.430 E	89: 9: 1: 656	75	2	62
51	78.4620 N 29.5120 E	89: 9: 1:1214	230	2	220
52	78.3660 N 30.0450 E	89: 9: 1:1320	232	2	222
53	78.2830 N 30.2720 E	89: 9: 1:1431	266	2	258



STA	POSITION		TIME	BOTTOM MIN		MAX
				DEPTH	OBS	OBS
54	78.1980	N 30.4420	E 89: 9: 1:1527	260	2	248
55	78.1090	N 30.2220	E 89: 9: 1:1640	304	2	290
56	78.0000	N 30.0000	E 89: 9: 1:18 0	295	2	284
57	78.0710	N 29.0120	E 89: 9: 1:1920	320	2	312
58	78.1460	N 28.0220	E 89: 9: 1:2048	322	2	312
59	77.5990	N 27.1260	E 89: 9: 1:2254	184	2	172
60	77.3680	N 27.1150	E 89: 9: 2: 127	147	2	136
61	77.1670	N 27.1280	E 89: 9: 2: 344	194	2	186
62	76.5750	N 27.1230	E 89: 9: 2: 6 5	117	2	106
63	76.3680	N 27.1270	E 89: 9: 2: 815	102	2	90
64	76.1600	N 27.1200	E 89: 9: 2:1035	146	2	134
65	78.0000	N 26.0000	E 89: 9: 2:11 0	167	2	158
66	78.1510	N 26.1170	E 89: 9: 3: 042	188	2	180
67	78.0510	N 25.0150	E 89: 9: 3: 2 8	102	2	92
68	78.3270	N 23.5910	E 89: 9: 3: 414	92	2	82
69	78.3460	N 24.3070	E 89: 9: 3: 456	123	2	114
70	78.3580	N 25.0050	E 89: 9: 3: 542	166	2	156
71	78.3770	N 25.2820	E 89: 9: 3: 629	140	2	130
72	78.3970	N 26.0090	E 89: 9: 3: 732	80	2	72
73	78.5010	N 27.0680	E 89: 9: 3:1015	118	2	108
74	78.5520	N 26.4510	E 89: 9: 3:1056	77	2	64
75	78.5980	N 26.2580	E 89: 9: 3:1140	175	2	164
76	79.0300	N 26.1000	E 89: 9: 3:1246	205	2	194
77	78.5010	N 25.1690	E 89: 9: 3:1539	138	2	130
78	78.5500	N 24.1850	E 89: 9: 3:18 0	200	2	194
79	79.0000	N 22.3900	E 89: 9: 3:2031	137	2	130
80	80.5980	N 17.2950	E 89: 9: 5:2215	544	2	538
81	81.0200	N 16.2900	E 89: 9: 5: 044	1195	2	1176
82	80.5500	N 16.4370	E 89: 9: 6: 334	1075	2	1058
83	80.5210	N 16.5150	E 89: 9: 6: 5 3	1000	2	990
84	80.4890	N 17.0030	E 89: 9: 6: 625	500	2	488
85	80.4710	N 17.0360	E 89: 9: 6: 7 5	255	2	244
86	80.4490	N 17.0910	E 89: 9: 6: 738	156	2	148
87	80.3960	N 17.2690	E 89: 9: 6: 832	171	2	164
88	84.4000	N 15.0800	E 89: 9: 6:14 0	1750	2	1200
89	80.4180	N 15.0960	E 89: 9: 6:15 0	570	2	556
90	80.3150	N 15.0020	E 89: 9: 6:1641	131	2	126
91	80.1790	N 13.1060	E 89: 9: 6:1922	90	2	80
92	80.2330	N 12.5830	E 89: 9: 6:20 2	146	2	136
93	80.2570	N 12.5340	E 89: 9: 6:2037	206	2	198
94	80.2760	N 12.4960	E 89: 9: 6:21 9	426	2	408
95	80.2850	N 12.4720	E 89: 9: 6:2146	568	2	554
96	80.3020	N 12.2340	E 89: 9: 6:2257	755	2	742
97	80.3270	N 11.1750	E 89: 9: 7: 340	911	2	900
98	80.3100	N 11.0400	E 89: 9: 7:1242	845	2	836
99	80.2730	N 10.5550	E 89: 9: 7:1359	684	2	674
100	80.2260	N 11.1470	E 89: 9: 7:15 9	485	2	448
101	80.1880	N 11.1930	E 89: 9: 7:1610	205	2	190
102	80.1690	N 11.3660	E 89: 9: 7:1650	187	2	172
103	80.1000	N 11.5940	E 89: 9: 7:1757	171	2	156
104	80.0500	N 11.5900	E 89: 9: 7:1840	75	2	64
105	80.0710	N 11.1390	E 89: 9: 7:1935	185	2	170
106	80.0760	N 11.0030	E 89: 9: 7:2012	315	2	306
107	80.0770	N 10.4630	E 89: 9: 7:2049	418	2	404
108	80.0870	N 10.2950	E 89: 9: 7:2124	515	2	506
109	80.1010	N 9.5810	E 89: 9: 7:2215	568	2	560
110	80.1270	N 9.0530	E 89: 9: 7:2341	541	2	534
111	80.1200	N 6.7880	E 89: 9: 8: 332	553	2	546
112	80.0950	N 6.0390	E 89: 9: 8: 658	716	2	712
113	79.5990	N 5.2520	E 89: 9: 8: 854	1000	2	996

STA	POSITION		TIME	BOTTOM DEPTH	MIN OBS	MAX OBS
114	79.5870	N 4.5010 E	89: 9: 8:1030	1250	2	1196
115	79.5640	N 3.4350 E	89: 9: 8:1226	2500	2	1184
116	79.4380	N 2.5600 E	89: 9: 8:21 0	4500	2	2516
117	79.1910	N 9.2690 E	89: 9: 9:15 9	177	2	168
118	79.1900	N 8.2000 E	89: 9: 9:1623	218	2	204
119	79.1890	N 8.0310 E	89: 9: 9:17 0	440	2	432
120	79.1920	N 7.4500 E	89: 9: 9:1739	787	2	784
121	79.1940	N 7.1340 E	89: 9: 9:19 0	1219	2	1184
122	79.1880	N 5.5940 E	89: 9: 9:2055	1700	2	1190
123	79.1900	N 3.5880 E	89: 9: 9:2341	3000	2	1200
124	79.0120	N 1.5760 E	89: 9:10: 4 9	2500	2	1162
125	78.4980	N .0010 E	89: 9:10: 657	2600	2	1188
126	78.4620	N 1.0450 W	89: 9:10:1230	2700	2	1192
127	78.3700	N .1200 E	89: 9:10:1840	1800	2	1200
128	78.2800	N 1.0000 W	89: 9:10:2351	3000	2	1168
129	78.2650	N 1.5600 W	89: 9:11:1010	2900	2	1192
130	78.0990	N .3890 W	89: 9:11:1649	3000	2	1200
131	77.4380	N .5860 W	89: 9:11:20 0	3000	2	1188
132	77.4410	N 1.0050 E	89: 9:11:2251	3150	2	1202
133	77.5970	N 1.0940 E	89: 9:12: 048	3100	2	1202
134	78.1020	N 1.1280 E	89: 9:12: 214	3100	2	1192
135	78.2120	N 1.2330 E	89: 9:12: 350	1400	2	1198
136	78.3130	N 1.2910 E	89: 9:12: 528	2400	2	1202
137	78.3600	N 1.2930 E	89: 9:12: 655	2400	2	1198
138	78.4600	N .5200 E	89: 9:12:1530	2300	2	1206
139	78.5010	N .0020 E	89: 9:12:20 0	2400	2	1196
140	78.4910	N 1.0040 E	89: 9:12:22 3	3700	2	1208
141	78.4490	N 2.0060 E	89: 9:12:2352	2400	2	1200
142	78.4470	N 2.0050 E	89: 9:13: 132	2400	2	1200
143	78.4500	N 4.0050 E	89: 9:13: 355	2400	2	1206
144	78.4480	N 5.0090 E	89: 9:13: 515	2400	2	1176
145	78.4500	N 6.0000 E	89: 9:13: 7 0	2340	2	1202
146	78.4490	N 7.0050 E	89: 9:13: 853	1500	2	1172
147	78.4520	N 7.3070 E	89: 9:13:1011	1141	2	1136
148	78.4500	N 8.0100 E	89: 9:13:1119	995	2	988
149	78.4480	N 8.3080 E	89: 9:13:1235	645	2	636
150	78.4410	N 9.0030 E	89: 9:13:1333	360	2	344
151	78.4490	N 9.3070 E	89: 9:13:1419	245	2	238
152	78.4480	N 10.0090 E	89: 9:13:1458	80	2	70

